



*Choice of every dentist*

**MOSSIDENT**

Dental Surgical Instruments Supplier



Dental Instruments  
**Catalogue**



# The Company

**Mossient** is basically the sister company of Mossi Surgical Co. that is separated for the dental field. We Mossi Surgical Co. are known as the best Manufacturing & Exporting company of Surgical Instruments, Dental Instrument.

We are Sialkot-Pakistan based company which is known as the motherland & hub of surgical industry. We are approaching the progressive market leaders of the world who are looking for a reliable manufacturer/supplier with the best products. We believe in commitment towards quality, which has a generation of skilled employees and quality vendors for raw material and with manufacturing experience of more than a decade in the field.

We are providing the best quality products at much competitive prices at higher Satisfaction level, than what you are currently receiving. We can make any kind of instrument, according to the samples, drawings, Designs, or Patterns on the demand of our prestigious Clients. If you are interested to design or change pattern & style of any instrument, you can freely contact us we will help you out.

Our wide range of products are as

Dental Instruments, General Surgery Instruments, Diagnostics Instruments, Orthopedic Instruments, Obstetrics-Gynecology Instruments, Hollow ware & Sterilization Instruments, Tc instruments, Dental implants, Orthodontics Instruments, Laboratory Instruments, Hospital Instruments Scissors & all sorts of Forceps.

## Vision

Mossident started with a Vision of becoming the most reliable source of Surgical and Dental instruments, and as a brand becoming the first choice of every Surgeon and dentist of the world.

## Mission

We are committed to manufacture high quality Surgical and Dental instruments, and provide health care professionals from all over the world with a wide range of the instruments at much affordable prices and True & honest commitment's.





**MOSSIDENT**  
Dental Surgical Instruments Supplier

Extracting Forceps  
fórceps de extracción  
forceps d'extraction  
pinze da estrazione  
ملقط الاستخراج



ENGLISH PATTERN



**1003**  
Fig. 1  
upper centrals & canines



**1004**  
Fig. 2  
upper laterals & canines



**1005**  
Fig. 3  
upper incisors & canines



**1006**  
Fig. 4  
upper incisors & canines



**1007**  
Fig. 7  
upper premolars



**1008**  
Fig. 8  
lower premolars



**1009**  
Fig. 13  
lower premolars





**MOSSIDENT**  
Dental Surgical Instruments Supplier

Extracting Forceps  
fórceps de extracción  
forceps d'extraction  
pinze da estrazione  
ملقط الاستخراج



ENGLISH PATTERN



**1010**  
Fig. 13S  
lower premolars  
for children.

**1011**  
Fig. 17  
upper molars, right

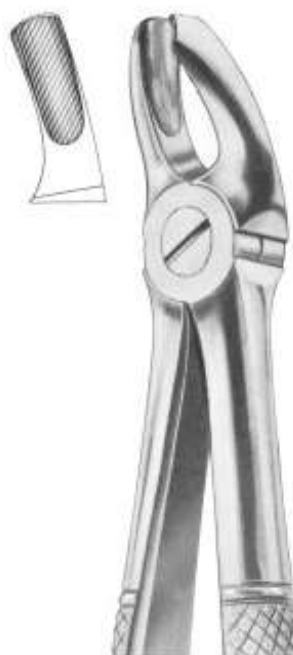

**1012**  
Fig. 18  
upper molars, left

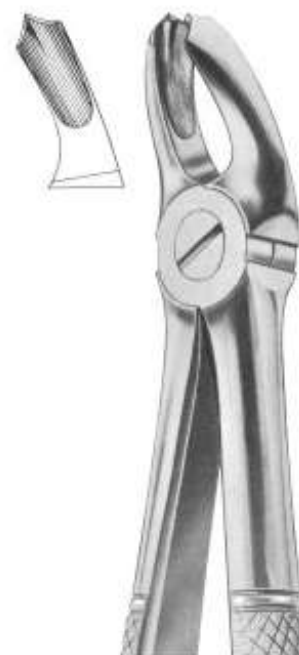

**1013**  
Fig. 18A  
upper molars



**1014**  
Fig. 18B  
upper molars



**1015**  
Fig. 19  
upper third molars





**MOSSIDENT**  
Dental Surgical Instruments Supplier

Extracting Forceps  
fórceps de extracción  
forceps d'extraction  
pinze da estrazione  
ملقط الاستخراج



ENGLISH PATTERN



**1016**  
Fig. 20  
upper third molars

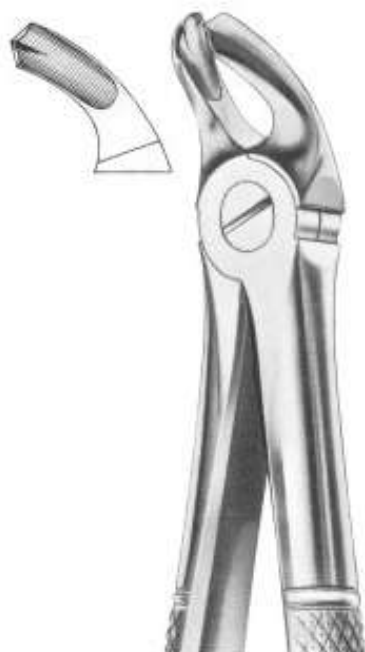

**1017**  
Fig. 21  
lower molars

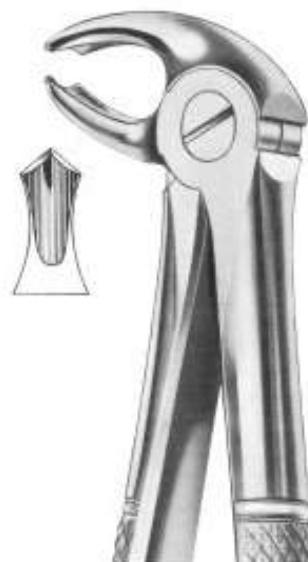

**1018**  
Fig. 22  
lower molars



**1019**  
Fig. 22S  
lower molars  
for children



**1020**  
Fig. 22G  
lower molars



**1021**  
Fig. 23  
lower molars right



**1022**  
Fig. 24  
lower molars left



**MOSSIDENT**  
Dental Surgical Instruments Supplier

Extracting Forceps  
fórceps de extracción  
forceps d'extraction  
pinze da estrazione  
ملقط الاستخراج



ENGLISH PATTERN



**1023**  
Fig. 29  
upper roots



**1024**  
Fig. 29S  
upper roots for children



**1025**  
Fig. 30  
upper roots

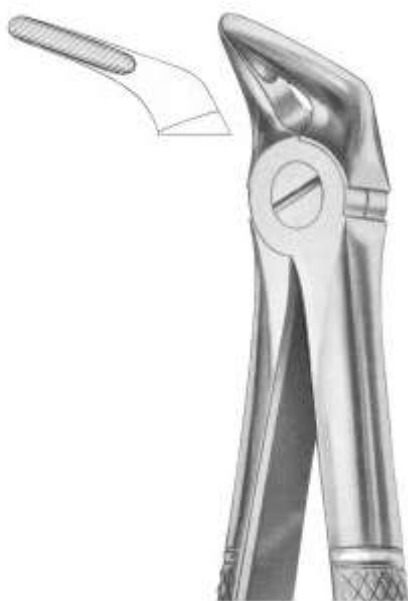

**1026**  
Fig. 31  
lower roots



**1027**  
Fig. 32  
lower molars



**1028**  
Fig. 30S  
upper roots  
for children



**MOSSIDENT**  
Dental Surgical Instruments Supplier

Extracting Forceps  
fórceps de extracción  
forceps d'extraction  
pinze da estrazione  
ملقط الاستخراج



ENGLISH PATTERN



**1029**  
Fig. 33  
lower roots



**1030**  
Fig. 33A  
lower roots



**1031**  
Fig. 33B  
lower roots



**1032**  
Fig. 33L  
lower roots



**1033**  
Fig. 37  
upper incisors  
for children



**1034**  
Fig. 33S  
lower roots  
for children





**MOSSIDENT**  
Dental Surgical Instruments Supplier

Extracting Forceps  
fórceps de extracción  
forceps d'extraction  
pinze da estrazione  
ملقط الاستخراج



ENGLISH PATTERN



**1035**  
Fig. 38  
lower incisors &  
canines for children



**1036**  
Fig. 39  
upper molars  
for children



**1037**  
Fig. 39R  
upper molars right  
for children



**1038**  
Fig. 39A  
upper molars  
for children



**1039**  
Fig. 40  
lower molars  
for children



**1040**  
Fig. 39L  
upper molars left  
for children



**MOSSIDENT**  
Dental Surgical Instruments Supplier

Extracting Forceps  
fórceps de extracción  
forceps d'extraction  
pinze da estrazione  
ملقط الاستخراج



ENGLISH PATTERN



**1041**  
Fig. 41  
upper roots



**1042**  
Fig. 44  
upper roots



**1043**  
Fig. 45  
lower roots



**1046**  
Fig. 50  
upper roots



**1044**  
Fig. 48  
lower roots



**1045**  
Fig. 49  
upper roots



**MOSSIDENT**  
Dental Surgical Instruments Supplier

Extracting Forceps  
fórceps de extracción  
forceps d'extraction  
pinze da estrazione  
ملقط الاستخراج



ENGLISH PATTERN



**1047**  
Fig. 51  
upper roots



**1048**  
Fig. 51A  
upper roots



**1049**  
Fig. 51L  
upper roots



**1050**  
Fig. 52  
upper roots



**1051**  
Fig. 52A  
upper teeth  
and resection



**1052**  
Fig. 51S  
upper roots  
for children





**MOSSIDENT**  
Dental Surgical Instruments Supplier

Extracting Forceps  
fórceps de extracción  
forceps d'extraction  
pinze da estrazione  
ملقط الاستخراج



ENGLISH PATTERN



**1053**  
Fig. 54  
for separating  
upper molars



**1054**  
Fig. 55  
for separating  
upper molars



**1055**  
Fig. 56  
for separating  
lower molars

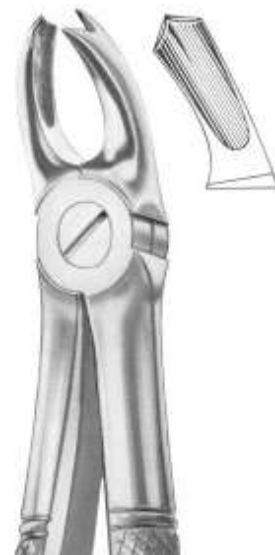

**1056**  
Fig. 65R  
upper molars  
right

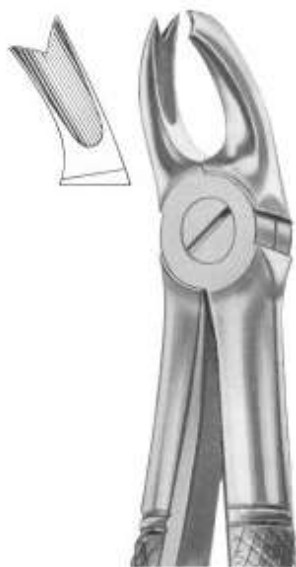

**1057**  
Fig. 65L  
upper molars left



**1058**  
Fig. 67  
upper third molars



**1059**  
Fig. 67A  
upper third molars



**MOSSIDENT**  
Dental Surgical Instruments Supplier

Extracting Forceps  
fórceps de extracción  
forceps d'extraction  
pinze da estrazione  
ملقط الاستخراج



ENGLISH PATTERN



**1060**  
Fig. 67 ½R  
upper third molars  
right



**1061**  
Fig. 67 ½L  
upper third molars  
left



**1062**  
Fig. 68  
lower roots

**1063**  
Fig. 68A  
lower roots



**1064**  
Fig. 73  
lower molars



**1065**  
Fig. 73R  
lower molars right



**1066**  
Fig. 73L  
lower molars left



**MOSSIDENT**  
Dental Surgical Instruments Supplier

Extracting Forceps  
fórceps de extracción  
forceps d'extraction  
pinze da estrazione  
ملقط الاستخراج



ENGLISH PATTERN



**1067**  
Fig. 73A  
lower molars



**1068**  
Fig. 73S  
lower molars



**1069**  
Fig. 73B  
lower molars for children



**1072**  
Fig. 73K  
lower molars  
for children



**1070**  
Fig. 74  
lower roots



**1071**  
Fig. 74D  
lower roots





**MOSSIDENT**  
Dental Surgical Instruments Supplier

Extracting Forceps  
fórceps de extracción  
forceps d'extraction  
pinze da estrazione  
ملقط الاستخراج



ENGLISH PATTERN



**1073**  
Fig. 74M  
lower roots



**1074**  
Fig. 74N  
lower roots



**1075**  
Fig. 74XN  
lower roots and  
crowded incisors



**1078**  
Fig. 76N  
upper roots



**1076**  
Fig. 75  
lower premolars



**1077**  
Fig. 76  
upper roots



**MOSSIDENT**

Dental Surgical Instruments Supplier

Extracting Forceps

fórceps de extracción

forceps d'extraction

pinze da estrazione

ملقط الاستخراج



ENGLISH PATTERN



**1079**  
Fig. 76S  
upper roots



**1080**  
Fig. 79  
lower third molars



**1081**  
Fig. 79A  
lower third molars



**1082**  
Fig. 81  
lower premolars  
and roots



**MOSSIDENT**  
Dental Surgical Instruments Supplier

Extracting Forceps  
fórceps de extracción  
forceps d'extraction  
pinze da estrazione  
ملقط الاستخراج



ENGLISH PATTERN



**1083**  
Fig. 86A  
lower molars



**1084**  
Fig. 86B  
lower molars



**1085**  
Fig. 86C  
lower molars



**1086**  
Fig. 87  
lower molars



**1087**  
Fig. 91  
for separating  
lower molars



**1088**  
Fig. 99  
lower molars





**MOSSIDENT**

Dental Surgical Instruments Supplier

Extracting Forceps

fórceps de extracción

forceps d'extraction

pinze da estrazione

ملقط الاستخراج



ENGLISH PATTERN



**1089**  
Fig. 101  
upper premolars  
and roots



**1090**  
Fig. 100  
upper roots



**1091**  
Fig. 99 1/4  
lower molars



**1092**  
Fig. 99 1/2  
lower molars



**MOSSIDENT**  
Dental Surgical Instruments Supplier

Extracting Forceps  
fórceps de extracción  
forceps d'extraction  
pinze da estrazione  
ملقط الاستخراج



ENGLISH PATTERN



**1093**  
Fig. 102  
upper molars right



**1094**  
Fig. 103  
upper molars left



**1095**  
Fig. 105  
lower incisors



**1096**  
Fig. 106  
lower incisors



**1097**  
Fig. 103  
upper canines



**MOSSIDENT**  
Dental Surgical Instruments Supplier

Extracting Forceps  
fórceps de extracción  
forceps d'extraction  
pinze da estrazione  
ملقط الاستخراج



ENGLISH PATTERN



**1098**  
Fig. 112  
upper roots



**1099**  
Fig. 113  
upper roots



**1101**  
Fig. 136  
upper premolars  
and roots



**1102**  
Fig. 137  
lower incisors  
and roots



**1100**  
Fig. 114  
upper roots



**1103**  
Fig. 143  
lower roots





# MOSSIDENT

Dental Surgical Instruments Supplier

Extracting Forceps

fórceps de extracción

forceps d'extraction

pinze da estrazione

ملقط الاستخراج



## ENGLISH PATTERN



**1104**  
MEAD (MD 1)  
upper anteriors,  
roots, incisors, canines



**1105**  
MEAD (MD 2)  
upper molars



**1106**  
MEAD (MD 3)  
lower roots

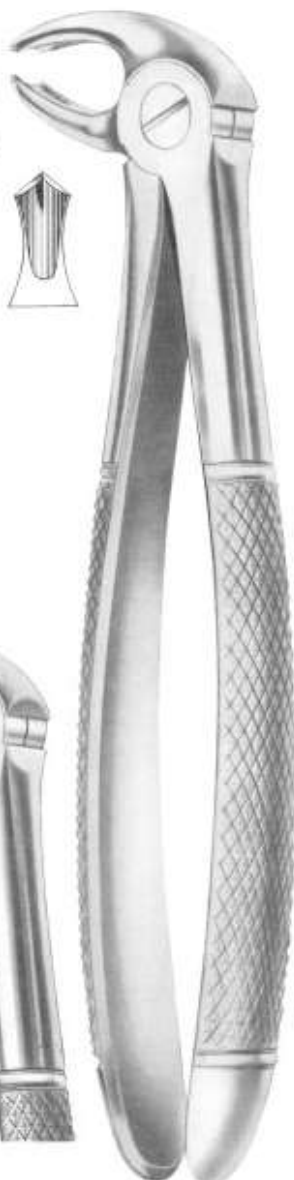

**1107**  
MEAD (MD 4)  
lower molars



**1108**  
FELSCH (Fig. 210)  
upper third molars



**1109**  
HERTZ (Fig. 211)  
lower incisors



**MOSSIDENT**  
Dental Surgical Instruments Supplier

Extracting Forceps  
fórceps de extracción  
forceps d'extraction  
pinze da estrazione  
ملقط الاستخراج



ENGLISH PATTERN



**1110**  
ROUTURIER (Fig. 212)  
( 22 ½ L )  
lower molars  
and wisdom left



**1111**  
ROUTURIER (Fig. 213)  
( 22 ½ R )  
lower molars  
and wisdom right



**1112**  
ROUTURIER (Fig. 214)  
( 22 ½ L )  
lower molars  
and wisdom left

**1113**  
ROUTURIER (Fig. 215)  
( 33 ½ R )  
lower molars  
and wisdom right



**1114**  
RESECTION FORCEPS  
( 216/Witzel )  
upper roots



# MOSSIDENT

Dental Surgical Instruments Supplier

Extracting Forceps

fórceps de extracción

forceps d'extraction

pinze da estrazione

ملقط الاستخراج



## ENGLISH PATTERN



**1115**  
Fig. 5



**1116**  
Fig. 6

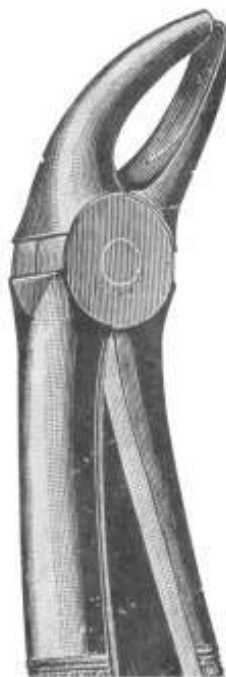

**1117**  
Fig. 9



**1118**  
Fig. 10



**1119**  
Fig. 11



**1120**  
Fig. 12



**1121**  
Fig. 14



**1122**  
Fig. 15





**MOSSIDENT**  
Dental Surgical Instruments Supplier

Extracting Forceps  
fórceps de extracción  
forceps d'extraction  
pinze da estrazione  
ملقط الاستخراج



ENGLISH PATTERN



1123  
Fig. 25



1124  
Fig. 26



1125  
Fig. 27



1126  
Fig. 28



1127  
Fig. 34



1128  
Fig. 35

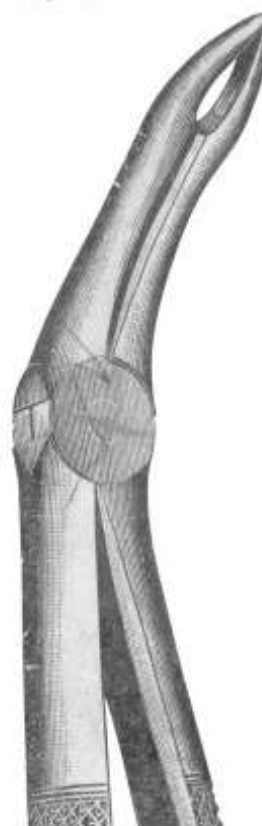

1129  
Fig. 42



1130  
Fig. 43



**MOSSIDENT**  
Dental Surgical Instruments Supplier

Extracting Forceps  
fórceps de extracción  
forceps d'extraction  
pinze da estrazione  
ملقط الاستخراج



ENGLISH PATTERN



1131  
Fig. 44A



1132  
Fig. 46

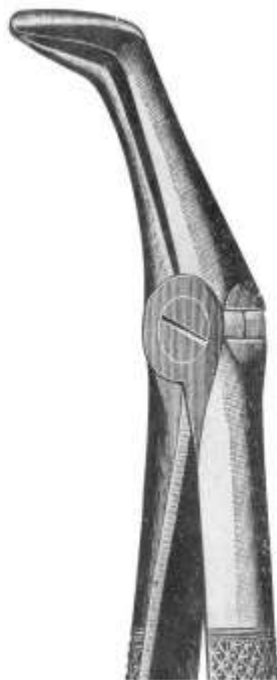

1133  
Fig. 47



1134  
Fig. 50A



1135  
Fig. 74R



1136  
Fig. 74L



1137  
Fig. 75R



1138  
Fig. 75L



**MOSSIDENT**  
Dental Surgical Instruments Supplier

Extracting Forceps  
fórceps de extracción  
forceps d'extraction  
pinze da estrazione  
ملقط الاستخراج



ENGLISH PATTERN



1139  
Fig. 94



1140  
Fig. 95



1141  
Fig. 98



1142  
Fig. 105



1143  
Fig. 106



1144  
Fig. 2002





# MOSSIDENT

Dental Surgical Instruments Supplier

Extracting Forceps

fórceps de extracción

forceps d'extraction

pinze da estrazione

ملقط الاستخراج



## ENGLISH PATTERN WITH FITTING HANDLE



**1145**  
Fig. 1  
upper laterals  
and canines



**1146**  
Fig. 2  
upper laterals  
and canines



**1147**  
Fig. 3  
upper incisors  
and canines

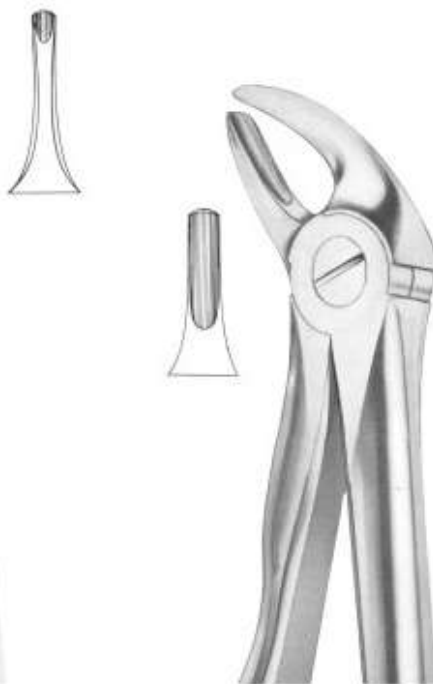

**1148**  
Fig. 4  
lower incisors  
and canines



**1149**  
Fig. 7  
upper premolars



**1150**  
Fig. 13  
lower premolars



**1151**  
Fig. 13S  
lower premolars  
for children



# MOSSIDENT

Dental Surgical Instruments Supplier

Extracting Forceps  
fórceps de extracción  
forceps d'extraction  
pinze da estrazione  
ملقط الاستخراج



## ENGLISH PATTERN WITH FITTING HANDLE



**1152**  
Fig. 17  
upper molars right



**1153**  
Fig. 18  
upper molars left



**1154**  
Fig. 18A  
upper molars



**1155**  
Fig. 18B  
upper molars



**1156**  
Fig. 19  
upper third molars



**1157**  
Fig. 22  
lower molars



**1158**  
Fig. 22S  
lower molars  
for children



# MOSSIDENT

Dental Surgical Instruments Supplier

Extracting Forceps

fórceps de extracción

forceps d'extraction

pinze da estrazione

ملقط الاستخراج



## ENGLISH PATTERN WITH FITTING HANDLE



**1159**  
Fig. 29  
upper roots



**1160**  
Fig. 29S  
upper roots  
for children



**1161**  
Fig. 30  
upper roots



**1162**  
Fig. 30S  
upper roots  
for children



**1163**  
Fig. 33  
lower roots



**1164**  
Fig. 33A  
lower roots



**1165**  
Fig. 33B  
lower roots



**MOSSIDENT**  
Dental Surgical Instruments Supplier

Extracting Forceps  
fórceps de extracción  
forceps d'extraction  
pinze da estrazione  
ملقط الاستخراج



ENGLISH PATTERN WITH FITTING HANDLE



**1166**  
Fig. 33L  
lower roots



**1167**  
Fig. 33S  
lower roots  
for children



**1168**  
Fig. 37  
upper incisors  
for children



**1169**  
Fig. 39  
upper incisors  
for children



**1170**  
Fig. 39A  
upper molars  
for children



**1171**  
Fig. 39R  
upper molars right  
for children



**1172**  
Fig. 39L  
upper molars left  
for children





**MOSSIDENT**  
Dental Surgical Instruments Supplier

Extracting Forceps  
fórceps de extracción  
forceps d'extraction  
pinze da estrazione  
ملقط الاستخراج



ENGLISH PATTERN WITH FITTING HANDLE



**1173**  
Fig. 41  
upper roots

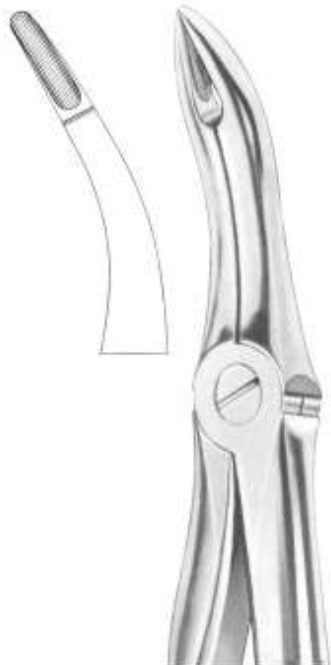

**1174**  
Fig. 44  
upper roots

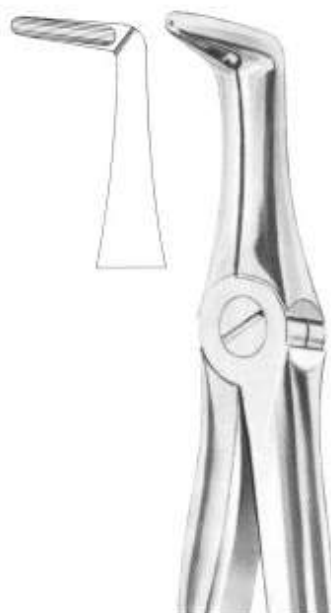

**1175**  
Fig. 45  
lower roots

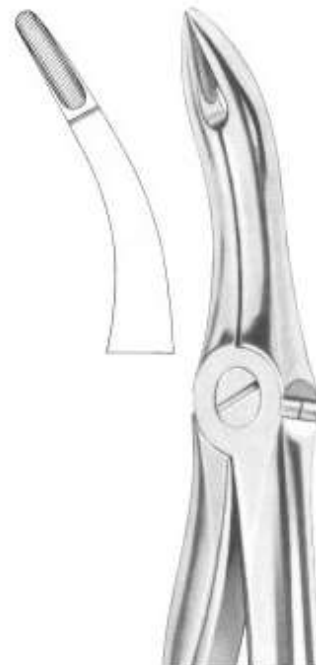

**1176**  
Fig. 48  
lower roots



**1177**  
Fig. 51  
upper roots



**1178**  
Fig. 51A  
upper roots



**1179**  
Fig. 51S  
upper roots  
for children



**MOSSIDENT**

Dental Surgical Instruments Supplier

Extracting Forceps  
fórceps de extracción  
forceps d'extraction  
pinze da estrazione  
ملقط الاستخراج



ENGLISH PATTERN WITH FITTING HANDLE



**1180**  
Fig. 51L  
upper roots



**1181**  
Fig. 52  
upper roots



**1182**  
Fig. 54  
for separating  
upper molars



**1183**  
Fig. 65R  
upper molars right



**1184**  
Fig. 65L  
upper molars left



**1185**  
Fig. 67  
upper third molars

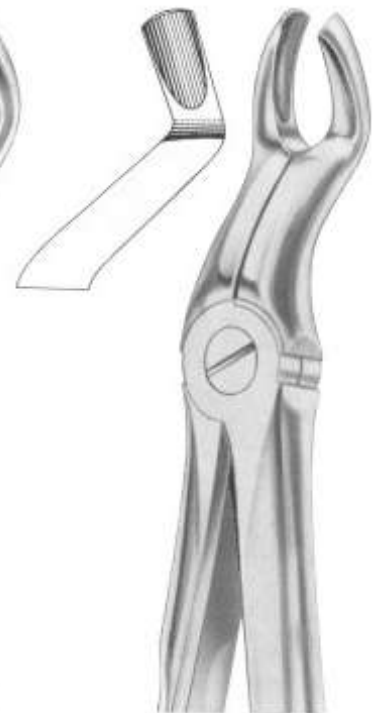

**1186**  
Fig. 67A  
upper third molars



**MOSSIDENT**  
Dental Surgical Instruments Supplier

Extracting Forceps  
fórceps de extracción  
forceps d'extraction  
pinze da estrazione  
ملقط الاستخراج



ENGLISH PATTERN WITH FITTING HANDLE

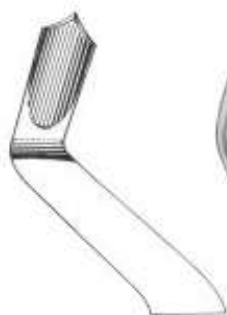

**1187**  
Fig. 67 1/2 R  
upper third molars  
right

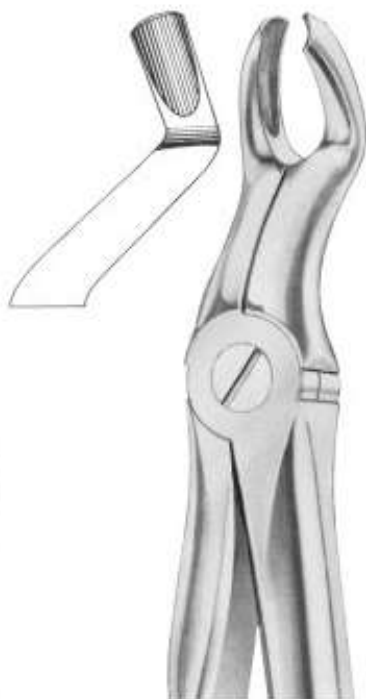

**1188**  
Fig. 67 1/2 L  
upper third molars  
left



**1189**  
Fig. 73  
lower molars



**1190**  
Fig. 74  
lower roots



**1191**  
Fig. 74M  
lower roots



**1192**  
Fig. 74N  
lower roots



**1193**  
Fig. 74XN  
lower roots and  
crowded incisors





# MOSSIDENT

Dental Surgical Instruments Supplier

Extracting Forceps

fórceps de extracción

forceps d'extraction

pinze da estrazione

ملقط الاستخراج



## ENGLISH PATTERN WITH FITTING HANDLE



**1194**  
Fig. 75  
lower premolars



**1195**  
Fig. 76  
upper roots



**1196**  
Fig. 76N  
upper roots



**1197**  
Fig. 81  
lower premolars  
and roots



**1198**  
Fig. 76A  
lower third molars



**1199**  
Fig. 79  
lower third molars



**MOSSIDENT**  
Dental Surgical Instruments Supplier

Extracting Forceps  
fórceps de extracción  
forceps d'extraction  
pinze da estrazione  
ملقط الاستخراج



ENGLISH PATTERN WITH FITTING HANDLE



**1200**  
Fig. 86A  
lower molars



**1201**  
Fig. 86B  
lower molars



**1202**  
Fig. 86C  
lower molars



**1203**  
Fig. 99  
lower molars



**1204**  
Fig. 99 1/4  
lower molars



**1205**  
Fig. 136  
upper premolars  
and roots



**1206**  
Fig. 143  
lower roots



**MOSSIDENT**  
Dental Surgical Instruments Supplier

Extracting Forceps  
fórceps de extracción  
forceps d'extraction  
pinze da estrazione  
ملقط الاستخراج



**FOR CHILDREN**



**1207**  
KLEIN (Fig. 217)  
upper incisors



**1208**  
KLEIN (Fig. 218)  
upper premolars



**1209**  
KLEIN (Fig. 219)  
upper roots



**1210**  
KLEIN (Fig. 220)  
upper molars



**1214**  
ALBRECHT  
Fig. 224  
Deciduous



**1215**  
ALBRECHT  
Fig. 225  
Deciduous



**1211**  
KLEIN (Fig. 221)  
lower incisors



**1212**  
KLEIN (Fig. 222)  
lower molars



**1213**  
KLEIN (Fig. 223)  
lower roots





**MOSSIDENT**  
Dental Surgical Instruments Supplier

Extracting Forceps  
fórceps de extracción  
forceps d'extraction  
pinze da estrazione  
ملقط الاستخراج



## SPLINTER FORCEPS

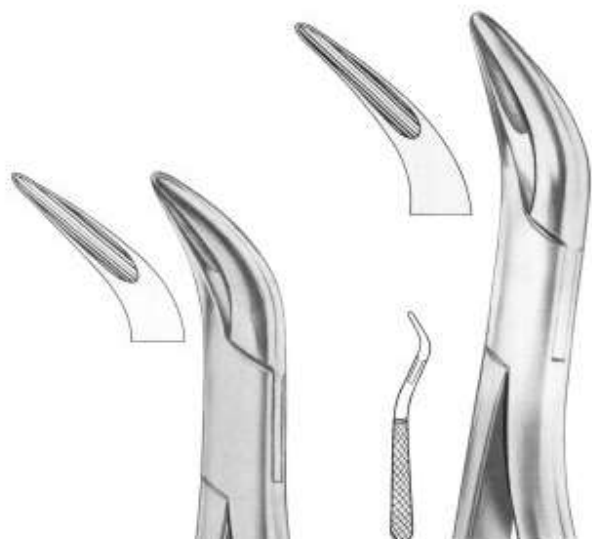

**1217**  
WITZEL  
Fig. 227  
upper roots



**1216**  
WITZEL  
Fig. 226  
lower roots



**1218**  
ARTHUR  
Fig. 228  
root fragments



**1219**  
STIEGLITZ  
Fig. 229  
root fragments



**1220**  
STIEGLITZ  
Fig. 230  
root fragments



**1221**  
RALK  
Fig. 231  
root fragments



# MOSSIDENT

Dental Surgical Instruments Supplier

Extracting Forceps  
fórceps de extracción  
forceps d'extraction  
pinze da estrazione  
ملقط الاستخراج



## AMERICAN PATTERN



**1222**  
W1-WINTER  
upper centrals  
and canines



**1223**  
Fig. 1  
upper incisors and roots



**1224**  
Fig. 2  
upper and lower roots



**1225**  
Fig. 4  
upper and lower premolars

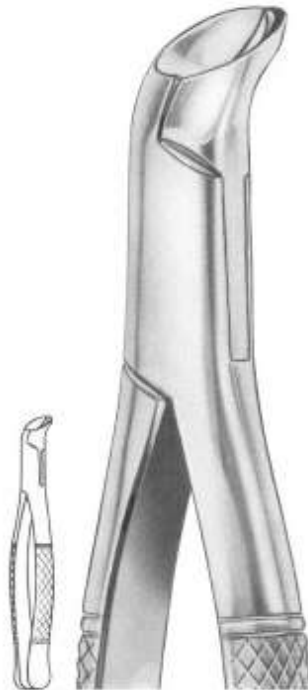

**1226**  
PHYSICK  
Fig. 5  
lower third molars



**1227**  
Fig. 6  
separating  
forceps



# MOSSIDENT

Dental Surgical Instruments Supplier

Extracting Forceps

fórceps de extracción

forceps d'extraction

pinze da estrazione

ملقط الاستخراج



## AMERICAN PATTERN



**1228**  
Fig. 7  
upper roots

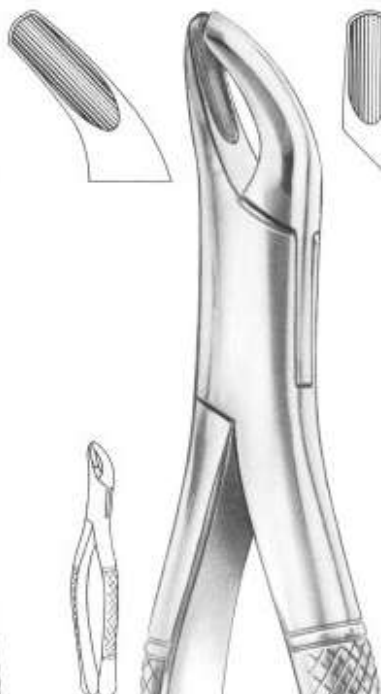

**1229**  
Fig. 8  
upper and lower  
third molars



**1231**  
Fig. 10H  
upper molars



**1232**  
Fig. 13  
upper incisors

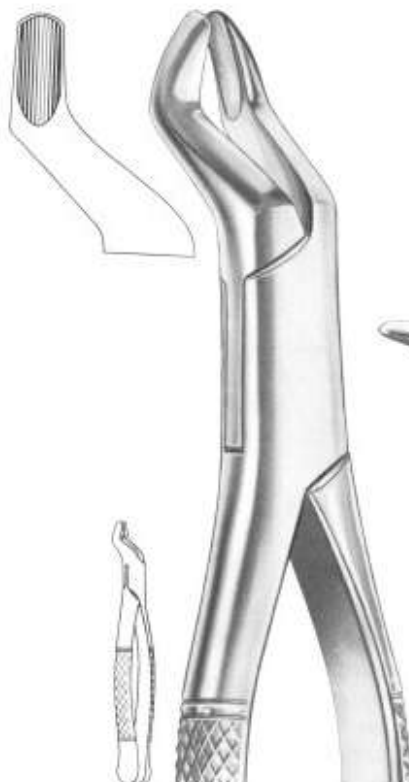

**1230**  
Fig. 10S  
upper molars



**1233**  
Fig. 14  
lower incisors





# MOSSIDENT

Dental Surgical Instruments Supplier

Extracting Forceps  
fórceps de extracción  
forceps d'extraction  
pinze da estrazione  
ملقط الاستخراج



## AMERICAN PATTERN



**1234**  
Fig. 16  
lower molars



**1235**  
HARRIS  
Fig. 15  
lower molars



**1237**  
HARRIS  
Fig. 18R  
upper molars right



**1238**  
HARRIS  
Fig. 18L  
upper molars left

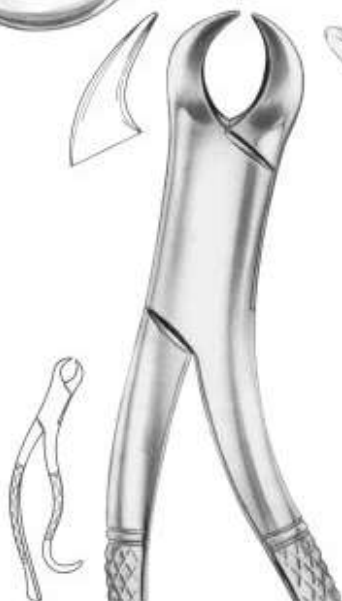

**1236**  
Fig. 16S  
lower molars  
for children



**1239**  
Fig. 17  
lower molars



**MOSSIDENT**  
Dental Surgical Instruments Supplier

Extracting Forceps  
fórceps de extracción  
forceps d'extraction  
pinze da estrazione  
ملقط الاستخراج



**AMERICAN PATTERN**

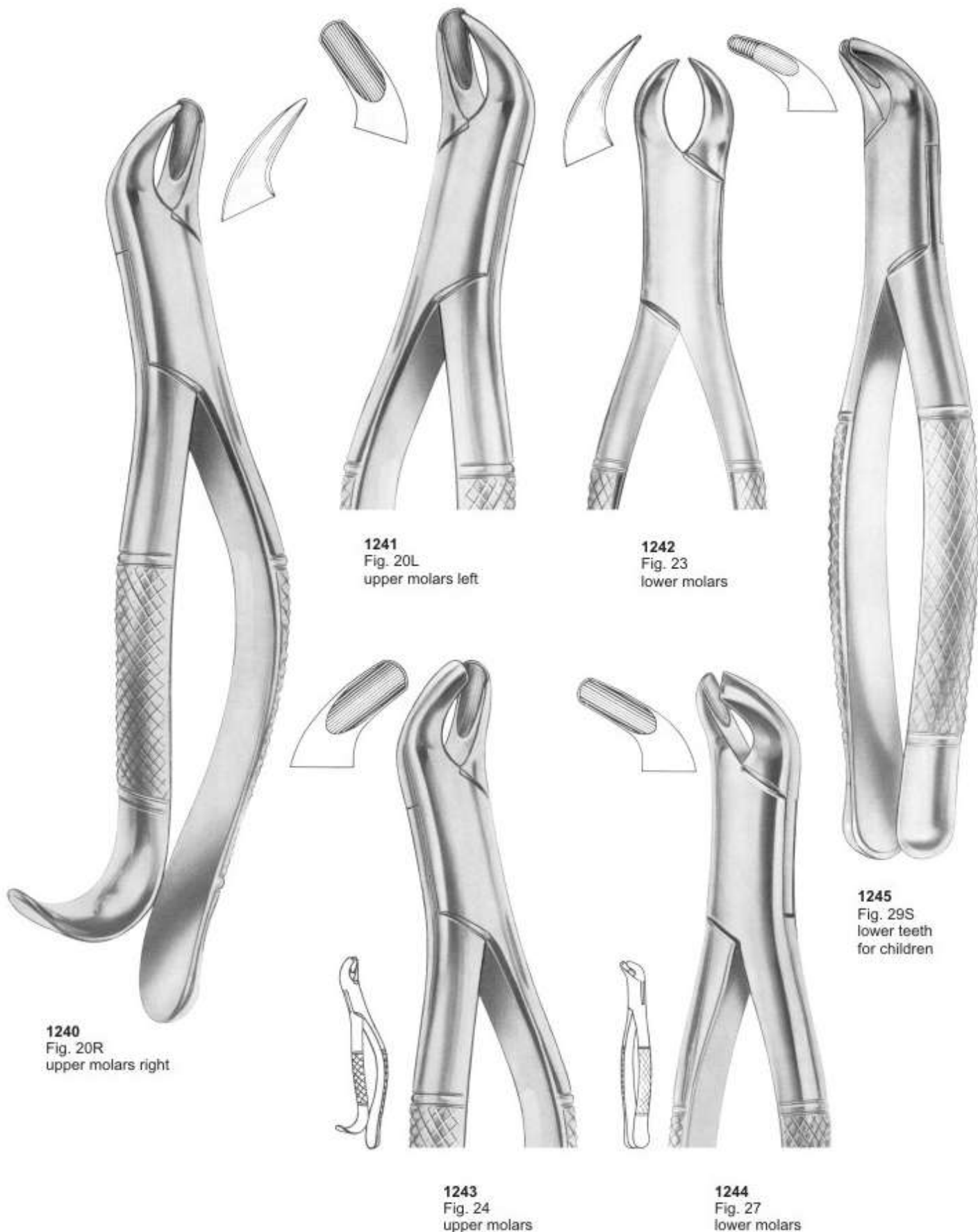



**MOSSIDENT**  
Dental Surgical Instruments Supplier

Extracting Forceps  
fórceps de extracción  
forceps d'extraction  
pinze da estrazione  
ملقط الاستخراج



**AMERICAN PATTERN**



**1246**  
Fig. 30S  
upper teeth  
for children



**1247**  
PARMLY  
Fig. 32  
upper premolars  
and molars



**1248**  
PARMLY  
Fig. 32A  
upper premolars  
and roots



**1249**  
Fig. 34  
lower anteriors  
and roots



**1250**  
Fig. 35  
upper roots



**1251**  
Fig. 36  
lower anteriors  
and roots





# MOSSIDENT

Dental Surgical Instruments Supplier

Extracting Forceps

fórceps de extracción

forceps d'extraction

pinze da estrazione

ملقط الاستخراج



## AMERICAN PATTERN



**1252**  
Fig. 37  
lower anteriors  
and roots



**1254**  
Fig. 53R  
upper molars right



**1255**  
Fig. 53L  
upper molars left



**1253**  
Fig. 38  
upper anteriors  
and roots



**1256**  
Fig. 62  
incisors, premolars,  
deciduous teeth



**1257**  
Fig. 65  
upper incisors  
and roots



# MOSSIDENT

Dental Surgical Instruments Supplier

Extracting Forceps

fórceps de extracción

forceps d'extraction

pinze da estrazione

ملقط الاستخراج



## AMERICAN PATTERN



**1258**  
TOMES  
Fig. 69  
upper and lower roots



**1259**  
TOMES  
Fig. 85  
lower canines,  
premolars and molars

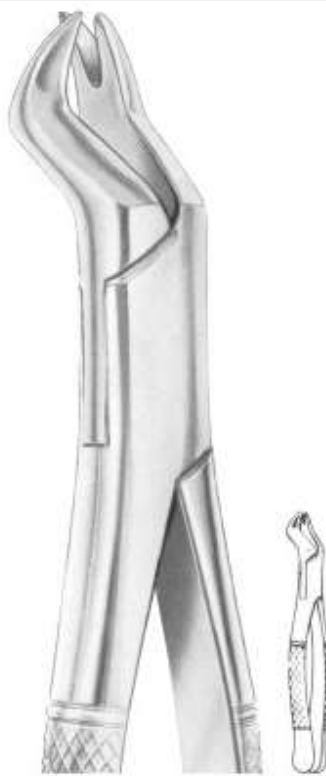

**1260**  
NEVIUS  
Fig. 88R  
upper molars right



**1261**  
THOMAS  
Fig. 85A  
lower canines,  
premolars and molars



**1262**  
NEVIUS  
Fig. 88L  
upper molars left



**MOSSIDENT**  
Dental Surgical Instruments Supplier

Extracting Forceps  
fórceps de extracción  
forceps d'extraction  
pinze da estrazione  
ملقط الاستخراج



**AMERICAN PATTERN**



**1263**  
KELLS  
Fig. 99A  
upper incisors,  
canines, premolars



**1264**  
Fig. 104  
upper third molars



**1266**  
HULL  
Fig. 101  
deciduous teeth



**1267**  
Fig. 103  
lower incisors,  
premolars



**1265**  
KELLS  
Fig. 99C  
upper incisors,  
canines, premolars





**MOSSIDENT**  
Dental Surgical Instruments Supplier

Extracting Forceps  
fórceps de extracción  
forceps d'extraction  
pinze da estrazione  
ملقط الاستخراج



**AMERICAN PATTERN**



**1268**  
CRYER  
Fig. 150  
lower incisors,  
premolars, roots



**1269**  
CRYER  
Fig. 150A  
upper incisors,  
premolars, roots



**1271**  
CRYER  
Fig. 151  
lower incisors,  
premolars, roots



**1272**  
CRYER  
Fig. 151A  
lower incisors,  
premolars, roots



**1270**  
CRYER  
Fig. 150S  
upper teeth for children



**1273**  
CRYER  
Fig. 151S  
lower teeth  
for children



**MOSSIDENT**  
Dental Surgical Instruments Supplier

Extracting Forceps  
fórceps de extracción  
forceps d'extraction  
pinze da estrazione  
ملقط الاستخراج



**AMERICAN PATTERN**



**1274**  
Fig. 203  
lower incisors  
and roots

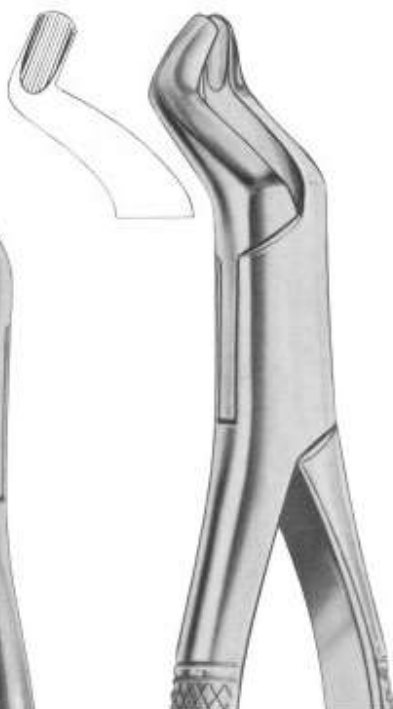

**1275**  
Fig. 210S  
upper third molars



**1277**  
Fig. 210H  
upper third molars



**1278**  
Fig. 213  
upper centrals and canines



**1276**  
Fig. 201  
upper incisors,  
canines, premolars



**1279**  
Fig. 217  
lower molars



# MOSSIDENT

Dental Surgical Instruments Supplier

Extracting Forceps

fórceps de extracción

forceps d'extraction

pinze da estrazione

ملقط الاستخراج



## AMERICAN PATTERN

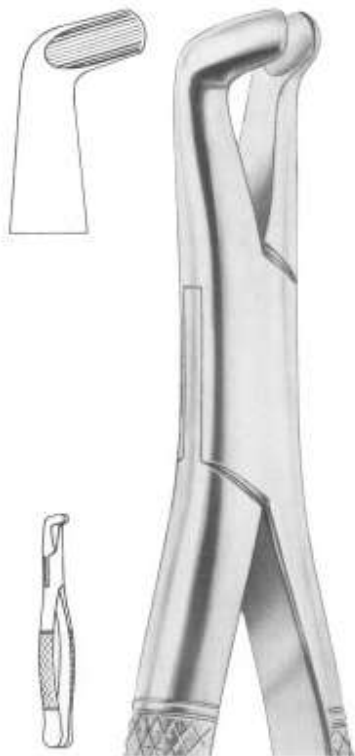

**1280**  
Fig. 222  
lower third molars



**1282**  
Fig. 286  
Swing lower molars



**1283**  
Fig. 288  
lower canines  
and premolars



**1281**  
Fig. 286  
upper incisors and roots





**MOSSIDENT**  
Dental Surgical Instruments Supplier

Extracting Forceps  
fórceps de extracción  
forceps d'extraction  
pinze da estrazione  
ملقط الاستخراج



**AMERICAN PATTERN**



**1284**  
COHEN  
Fig. 310  
universal forceps

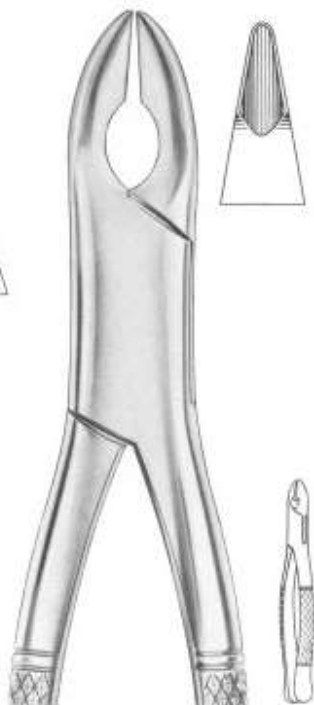

**1285**  
NEVIUS  
Fig. 320/10S  
upper canines



**1287**  
NEVIUS  
Fig. 325/10H  
upper canines



**1286**  
HENAHAN  
Fig. 315/1A  
upper incisors



**1288**  
STANDARD  
Fig. 330/4  
upper third molars



**MOSSIDENT**

Dental Surgical Instruments Supplier

Extracting Forceps

fórceps de extracción

forceps d'extraction

pinze da estrazione

ملقط الاستخراج



**AMERICAN PATTERN**



**1289**  
WOODWARD  
Fig. 335/FH  
lower molars

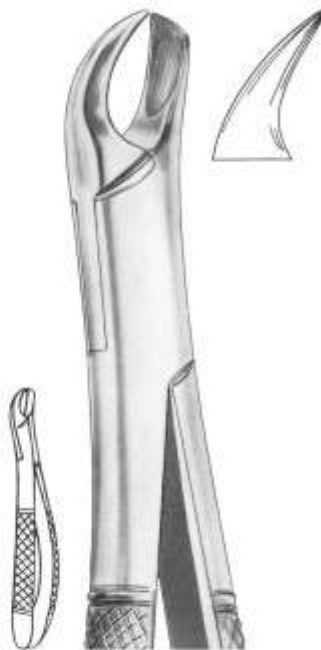

**1290**  
Fig. 340/89  
upper molars right



**1292**  
Fig. 345/90  
upper molars left

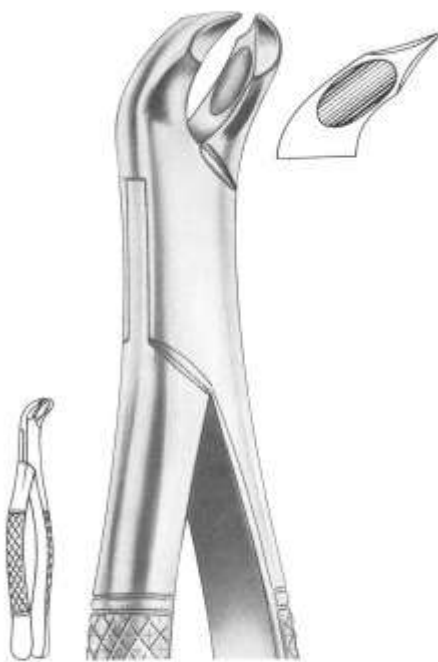

**1291**  
WOODWARD  
Fig. 335/FS  
lower molars



**MOSSIDENT**  
Dental Surgical Instruments Supplier

Extracting Forceps  
fórceps de extracción  
forceps d'extraction  
pinze da estrazione  
ملقط الاستخراج



**AMERICAN PATTERN**



**1293**  
Fig. 350/23S  
lower molars



**1294**  
Fig. 355/23SK  
lower molars



**1295**  
Forcep Fig. 301



**1295-A**  
Forcep Fig. 300



**1296**  
Fig. 360/17SK  
lower molars



**1297**  
Fig. 365/150SK  
upper anteriors  
and roots



**1298**  
Fig. 370/151SK  
lower anteriors  
and roots





**MOSSIDENT**

Dental Surgical Instruments Supplier

Root Elevators  
elevadores de raíces  
élévateurs de racine  
ascensori per radici  
مصاعد جذرية



**PERIOSTEEL ELEVATORS**



**1299**  
Molt 9



**1300**  
Allen 9A



**1301**  
Prichard



**1302**  
Seldin



**1303**  
Goldman- Fox 14



**1304**  
West  
Dell W2



# MOSSIDENT

Dental Surgical Instruments Supplier

Root Elevators  
elevadores de raíces  
élevateurs de racine  
ascensori per radici  
مصاعد جذرية



## PERIOSTEEL ELEVATORS

### Heidbrink Root - Tip Picks

#### Root Tip



1305  
DEL 78



1306  
DEL 79



1307  
DEL 80



1308  
DEL H1



1309  
DEL H2



1310  
DEL H3



1311  
DEL H2-3



1312  
POTT  
6X

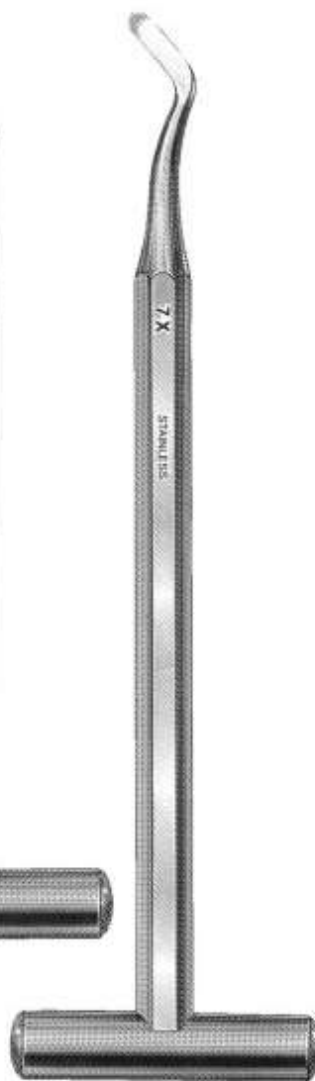

1313  
POTT  
7X



**MOSSIDENT**

Dental Surgical Instruments Supplier

Root Elevators  
elevadores de raíces  
élévateurs de racine  
ascensori per radici  
مصاعد جذرية



## PERIOSTEEL ELEVATORS



1314  
BUSER



1315  
OHI 10



1316  
HOWARD 9H



1317  
FREER



1318  
FREER 15



1319  
FREER 16





# MOSSIDENT

Dental Surgical Instruments Supplier

Root Elevators  
elevadores de raíces  
élevateurs de racine  
ascensori per radici  
مصاعد جذرية



## ROOT ELEVATORS

lower jaw, left side

lower jaw, right side



**1320**  
BEIN  
Fig. 4



**1331**



**1332**



**1321**  
BEIN  
1.0 mm



**1322**  
BEIN  
1.5 mm



**1323**  
BEIN  
2.0 mm



**1324**  
BEIN  
2.5 mm



**1325**  
BEIN  
3.0 mm



**1326**  
BEIN  
3.5 mm



**1327**  
BEIN  
4.0 mm



**1328**  
BEIN  
4.5 mm



**1329**  
BEIN  
5.0 mm



**1330**  
BEIN  
5.5 mm





**MOSSIDENT**  
Dental Surgical Instruments Supplier

Root Elevators  
elevadores de raíces  
élevateurs de racine  
ascensori per radici  
مصاعد جذرية



## ROOT ELEVATORS



**1334**  
BEIN  
Fig. 1



**1335**  
BEIN  
Fig. 2



**1336**  
BEIN  
Fig. 0



**1337**  
BEIN  
Fig. 3



**1333**  
BEIN



**1338**  
BEIN  
Fig. 4



**1339**  
BEIN  
Fig. 5



**1340**  
BEIN  
Fig. 6



**MOSSIDENT**  
Dental Surgical Instruments Supplier

Root Elevators  
elevadores de raíces  
élevateurs de racine  
ascensori per radici  
مصاعد جذرية



## ROOT ELEVATORS



**1341**  
CRYER  
Fig. 3



**1342**  
CRYER  
Fig. 4



**1343**  
CRYER  
Fig. 12



**1344**  
CRYER  
Fig. 27



**1345**  
CRYER  
Fig. 28



**1346**  
CRYER  
Fig. 27S



**1347**  
CRYER  
Fig. 28S



**1348**  
SELDIN  
Fig. 2



**1349**  
SELDIN  
Fig. 3



**1350**  
SELDIN  
Fig. 4L



**1351**  
SELDIN  
Fig. 4R



**1352**  
SELDIN  
Fig. 1L



**1353**  
SELDIN  
Fig. 1R





# MOSSIDENT

Dental Surgical Instruments Supplier

Root Elevators  
elevadores de raíces  
élevateurs de racine  
ascensori per radici  
مصاعد جذرية



## SAW ELEVATORS & ROOT SCREWS



1354



1355



1356



1357



1358



1359



1360

### Root Screws



1362  
Morrison  
2.0 mm



1363  
Morrison  
2.5 mm



1364  
Morrison  
3.0 mm



1361  
Morrison  
3.5 mm



# MOSSIDENT

Dental Surgical Instruments Supplier

Root Elevators  
elevadores de raíces  
élevateurs de racine  
ascensori per radici  
مصاعد جذرية



## ROOT ELEVATORS



**1365**  
IS-APICAL



**1366**  
APICAL  
2 mm  
Fig. 1



**1367**  
APICAL  
3 mm  
Fig. 2



**1368**  
APICAL  
4 mm  
Fig. 3



**1369**  
APICAL  
4.5 mm  
Fig. 4



**1370**  
APICAL  
2 mm  
Fig. 5



**1371**  
APICAL  
3 mm  
Fig. 6



**1372**  
APICAL  
4 mm  
Fig. 7



**1373**  
APICAL  
4.5 mm  
Fig. 8



**1374**  
APICAL  
Fig. 9



**1375**  
WINTER  
Fig. 14 L



**1376**  
WINTER  
Fig. 14 R



**1377**  
HEIDBRINK  
Fig. 1



**1378**  
HEIDBRINK  
Fig. 2



**1379**  
FLOHR  
Fig. 1



**1380**  
FLOHR  
Fig. 2



**1381**  
APICAL  
Fig. 1



**1382**  
APICAL  
Fig. 2



**MOSSIDENT**

Dental Surgical Instruments Supplier

Root Elevators  
elevadores de raíces  
élevateurs de racine  
ascensori per radici  
مصاعد جذرية



## ROOT ELEVATORS



**1383**  
IS-CRYER



**1384**  
CRYER  
Fig. 1



**1385**  
CRYER  
Fig. 2



**1386**  
IS-COUPLAND



**1387**  
COUPLAND  
Fig. 1



**1388**  
COUPLAND  
Fig. 2



**1389**  
COUPLAND  
Fig. 3





**MOSSIDENT**

Dental Surgical Instruments Supplier

Root Elevators  
elevadores de raíces  
élevateurs de racine  
ascensori per radici  
مصاعد جذرية



## ROOT ELEVATORS



**1390**  
Fig. 1



**1391**  
Fig. 2

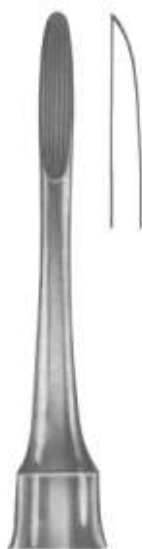

**1392**  
Fig. 3



**1393**  
FLOHR  
Fig. 1



**1394**  
FLOHR  
Fig. 2



**1395**  
FLOHR  
Fig. 3



# MOSSIDENT

Dental Surgical Instruments Supplier

Root Elevators  
elevadores de raíces  
élevateurs de racine  
ascensori per radici  
مصاعد جذرية



## ROOT ELEVATORS



**1396**  
KOPP  
Fig. 1



**1397**  
KOPP  
Fig. 2



**1403**  
KOPP  
Fig. 1



**1404**  
KOPP  
Fig. 2



**1396**  
KOPP



**1398**  
KOPP  
Fig. 3



**1399**  
KOPP  
Fig. 4



**1402**  
KOPP



**1405**  
KOPP  
Fig. 3



**1406**  
KOPP  
Fig. 4



**1400**  
KOPP  
Fig. 5



**1401**  
KOPP  
Fig. 6



**MOSSIDENT**  
Dental Surgical Instruments Supplier

Root Elevators  
elevadores de raíces  
élevateurs de racine  
ascensori per radici  
مصاعد جذرية



## ROOT ELEVATORS



**1407**  
HYLIN



**1407**  
HYLIN  
Fig. 1



**1408**  
HYLIN  
Fig. 2



**1409**  
BEIN

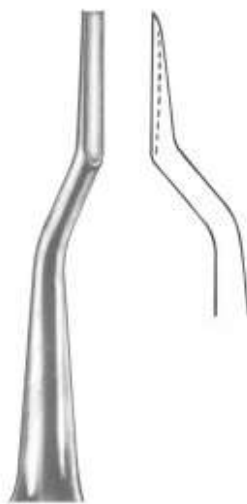

**1409**  
BEIN  
Fig. 1

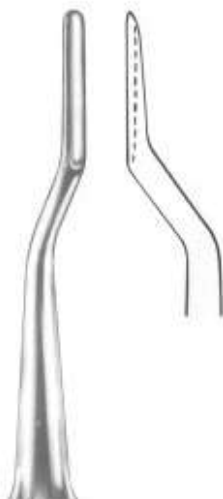

**1411**  
BEIN  
Fig. 3

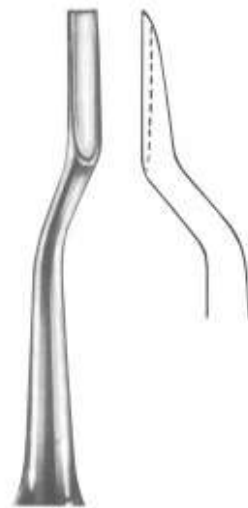

**1410**  
BEIN  
Fig. 2

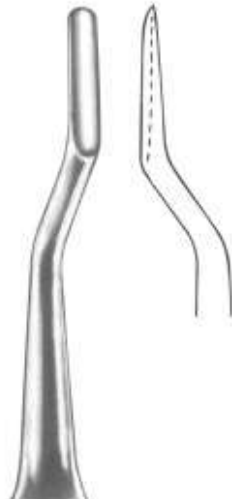

**1412**  
BEIN  
Fig. 4





**MOSSIDENT**

Dental Surgical Instruments Supplier

Root Elevators  
elevadores de raíces  
élevateurs de racine  
ascensori per radici  
مصاعد جذرية



## ROOT ELEVATORS



**1413**  
WARWICK-JAMES  
Fig. 1



**1413**  
Warwick-James  
Fig. 2



**1414**  
Warwick-James  
Fig. 3

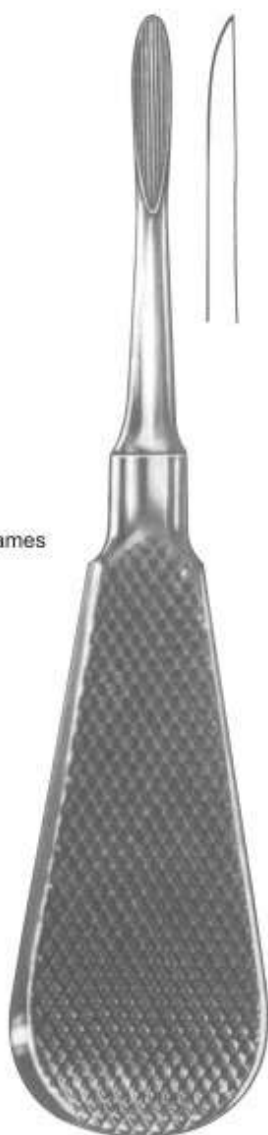

**1415**  
London-Hospital  
Fig. 1



**1415**  
London-Hospital  
Fig. 2



**1416**  
London-Hospital  
Fig. 3



**1417**  
OTT



# MOSSIDENT

Dental Surgical Instruments Supplier

Root Elevators  
elevadores de raíces  
élevateurs de racine  
ascensori per radici  
مصاعد جذرية



## ROOT ELEVATORS



1418  
CHOMPRET  
Fig. 1



1419  
CHOMPRET  
Fig. 2



1420  
CHOMPRET  
Fig. 3



1421  
CHOMPRET  
Fig. 4



1423  
Fig. 1



1422  
Fig. 2

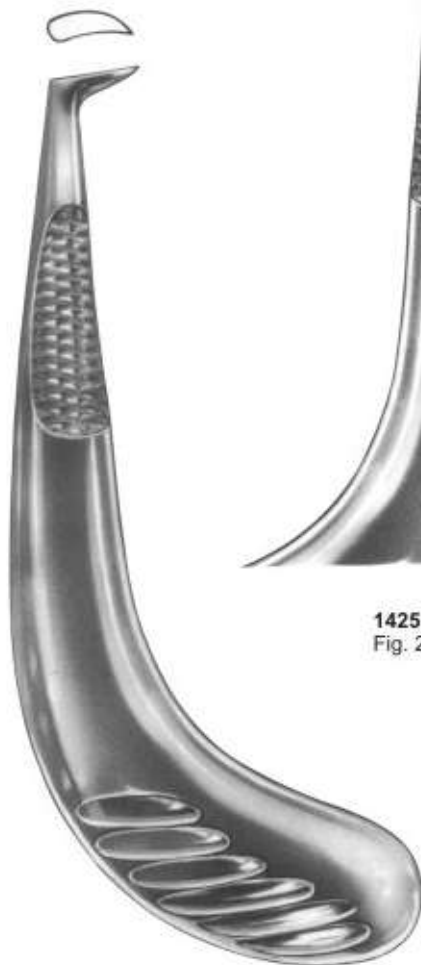

1424  
Fig. 1



1425  
Fig. 2



1426  
APICAL



# MOSSIDENT

Dental Surgical Instruments Supplier

Root Elevators  
elevadores de raíces  
élevateurs de racine  
ascensori per radici  
مصاعد جذرية



## ROOT TIP ELEVATORS



1427  
IS-Fig. 1



1428  
Fig. 2



1429  
Fig. 3



1430  
HEIDBRINK  
Fig. 1



1431  
HEIDBRINK  
Fig. 2



1432  
HEIDBRINK  
Fig. 3



1438  
MEAD  
MD1



1433  
LECLUSE



1434  
MEAD  
MD-5 A



1435  
MEAD  
MD-6 A



1436  
MEAD  
MD-7 A



1437  
MEAD  
MD-8



**MOSSIDENT**

Dental Surgical Instruments Supplier

Root Elevators  
elevadores de raíces  
élevateurs de racine  
ascensori per radici  
مصاعد جذرية



## ROOT ELEVATORS



**1439**  
WINTER  
Fig. 1L



**1440**  
WINTER  
Fig. 1R



**1441**  
WINTER  
Fig. 2L



**1442**  
WINTER  
Fig. 2R

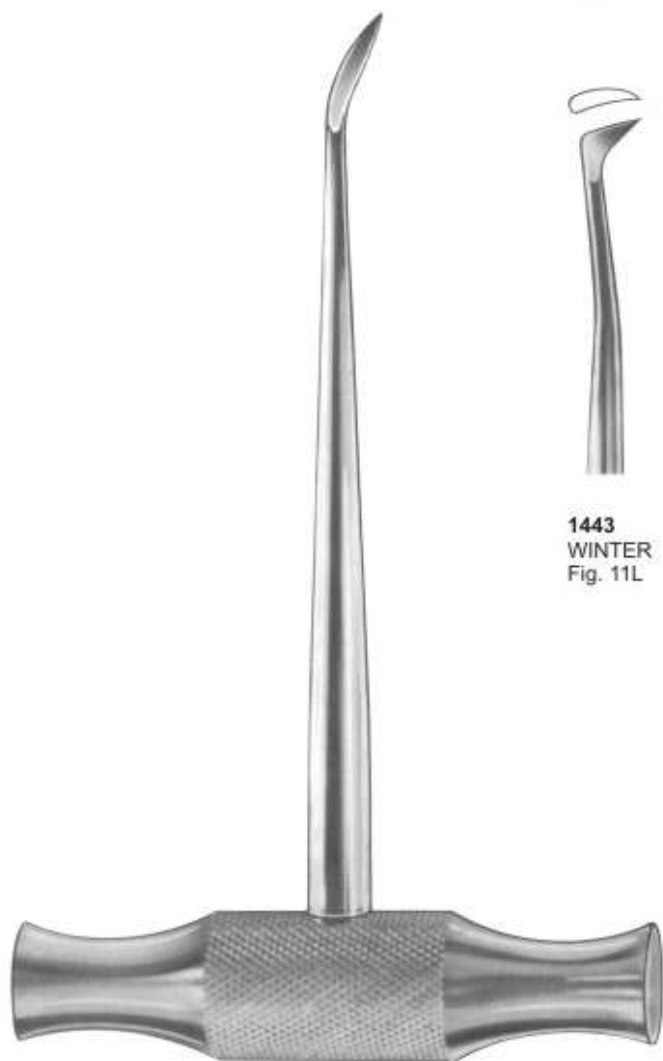

**1439**  
WINTER



**1443**  
WINTER  
Fig. 11L



**1444**  
WINTER  
Fig. 11R



**1445**  
WINTER  
Fig. 12L



**1446**  
WINTER  
Fig. 12R



**1447**  
WINTER  
Fig. 14L



**1448**  
WINTER  
Fig. 14R





# MOSSIDENT

Dental Surgical Instruments Supplier

Root Elevators  
elevadores de raíces  
élévateurs de racine  
ascensori per radici  
مصاعد جذرية



## ROOT ELEVATORS



**1449**  
BARRY  
Fig. 1



**1450**  
BARRY  
Fig. 2



**1451**  
BARRY  
Fig. 3



**1452**  
BARRY  
Fig. 4



**1449**  
BARRY



**1453**  
BARRY  
Fig. 11



**1454**  
BARRY  
Fig. 12



**1455**  
BARRY  
Fig. 17



**1456**  
BARRY  
Fig. 18



# MOSSIDENT

Dental Surgical Instruments Supplier

Root Elevators  
elevadores de raíces  
élévateurs de racine  
ascensori per radici  
مصاعد جذرية



## ROOT ELEVATORS



**1458**  
CRYER  
Fig. 26



**1459**  
SELDIN  
Fig. 27



**1460**  
CRYER  
Fig. 28



**1461**  
CRYER  
Fig. 29



**1462**  
HEIDBRINK  
Fig. 22



**1463**  
HEIDBRINK  
Fig. 23



**1457**



# MOSSIDENT

Dental Surgical Instruments Supplier

Root Elevators  
elevadores de raíces  
élevateurs de racine  
ascensori per radici  
مصاعد جذرية



## ROOT ELEVATORS



1465  
KOPP  
Fig. 31



1466  
KOPP  
Fig. 32



1467  
KOPP  
Fig. 33



1468  
KOPP  
Fig. 34



1469  
KOPP  
Fig. 35



1470  
KOPP  
Fig. 44



1464



**MOSSIDENT**

Dental Surgical Instruments Supplier

Root Elevators  
elevadores de raíces  
élevateurs de racine  
ascensori per radici  
مصاعد جذرية



**ROOT ELEVATORS**



**1472**  
**HEIDBRINK**  
Fig. 10



**1473**  
**WINTER**  
Fig. 11



**1474**  
**WINTER**  
Fig. 12



**1475**  
**BARRY**  
Fig. 17



**1476**  
**BARRY**  
Fig. 18



**1477**  
**BARRY**  
Fig. 20



**1471**

**Root Elevators according to Dr. Sader,  
with interchangeable working tips**

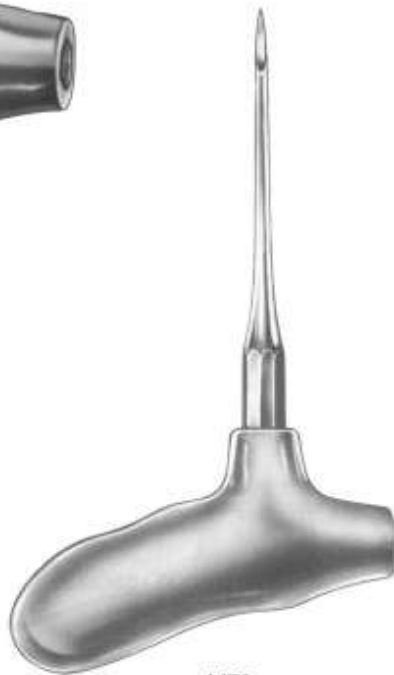

**1478**



**1479**



**1480**





# MOSSIDENT

Dental Surgical Instruments Supplier

Root Elevators  
elevadores de raíces  
élevateurs de racine  
ascensori per radici  
مصاعد جذرية



## LUXATORS / PLASTIC HANDLE ELEVATORS

1481

Root Elevator, Plastic Handle, Set of 10 Pcs

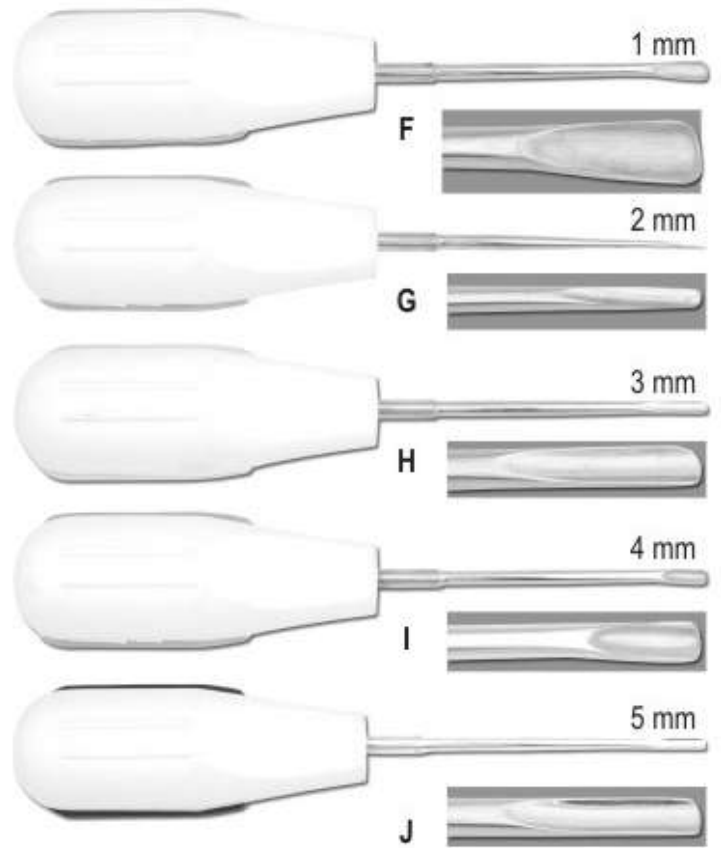
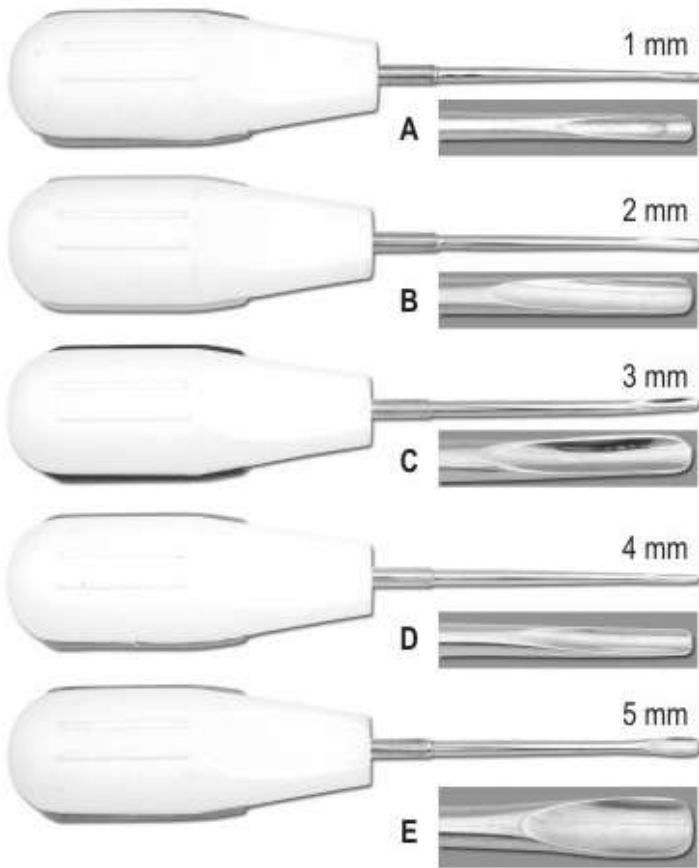

1482

Root Elevator, Plastic Handle, Set of 5 Pcs

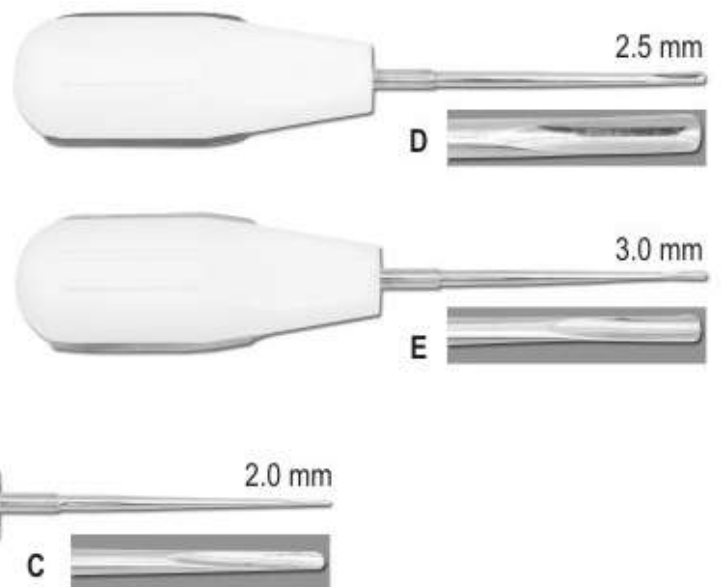
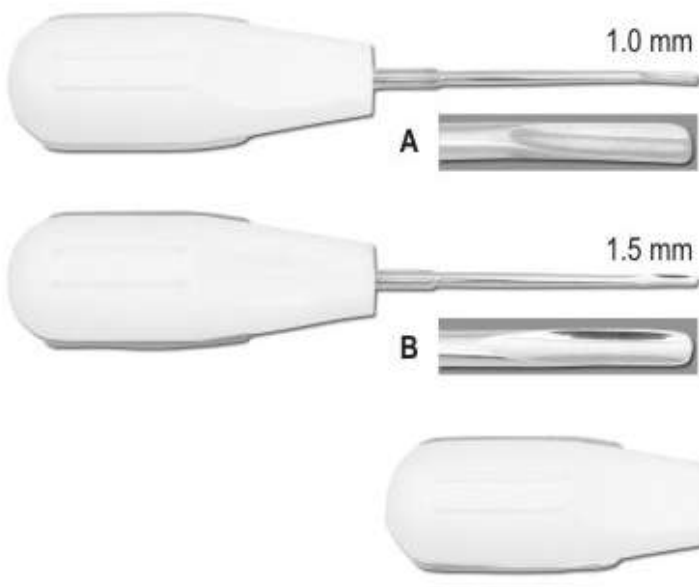



**SCALPEL HANDLES**



**1483**  
Scalpel Handle Angle Of Blade Adjusts To Easily Get Around Corners  
Adjustment Sets Blade From Straight To Back Angled  
Locks In At 90°, 60°, 30°, Straight, -30°, -60° Angles



**1484**  
Scalpel Handle  
Fig. 5



**1485**  
Scalpel Handle  
Curved



**1486**  
Fig. 3L



**1487**  
Fig. 7



**1488**  
Scalpel Handle  
Fig. 4L, Curved  
20 cm



**1489**  
Fig. 3



**1490**  
Fig. 3G



**1491**  
Fig. 4



**1492**



**1493**  
Scalpel Handle  
4 D 14.0 cm



**1494**  
Mess Holders



**1495**  
Gouge  
Blade Handle  
Fig. 2 / 11.5 cm



## HANDLES



**1496**

Handle No. 2 Standard Single Ended



**1497**

Handle Single Ended



**1498**

Handle Single Ended



**1499**

Handle Single Ended

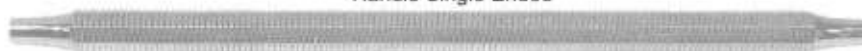

**1500**

Octagonal Double Ended



**1501**

Octagonal Double Ended



**1502**

Octagonal Double Ended



**1503**

Handle No. 2 (Standard Double Ended)



**1504**

Octagonal Double Ended



**1505**

Tactile Tone Double Ended



**1506**

Tactile Tone Double Ended

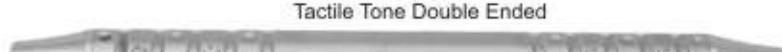

**1507**

Tactile Tone Double Ended



**1508**

Handle, Double Ended



**1509**

Double Ended



**1510**

Tactile Tone Double Ended

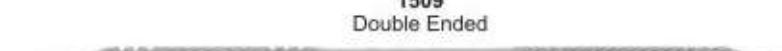

**1511**

Tactile Tone Double Ended



**1511**

Tactile Tone Double Ended



**1511**

Tactile Tone Double Ended





# MOSSIDENT

Dental Surgical Instruments Supplier

Surgery Instruments  
instrumentos de cirugia  
instruments de chirurgie  
ascensori per radici  
أدوات الجراحة



## HANDLES & MOUTH MIRRORS

### Mouth Mirrors, Magnifying 1513-A Plain 1512-B

Fig. 00	Ø	8 mm
Fig. 0	Ø	10 mm
Fig. 1	Ø	14 mm
Fig. 2	Ø	16 mm
Fig. 3	Ø	18 mm
Fig. 4	Ø	20 mm
Fig. 5	Ø	22 mm
Fig. 6	Ø	24 mm
Fig. 7	Ø	26 mm
Fig. 8	Ø	28 mm
Fig. 9	Ø	30 mm
Fig. 10	Ø	32 mm

1513-A

Plane		
1514 Fig.6 Ø 26 mm	1515 Fig.5 Ø 24 mm	1516 Fig.4 Ø 22 mm
Magnifying		
1517 Fig.6 Ø 26 mm	1518 Fig.5 Ø 24 mm	1519 Fig.4 Ø 22 mm
Front surface		
1520 Fig.6 Rhodium Ø 26 mm Front surface	1521 Fig.5 Rhodium Ø 24 mm Front surface	1522 Fig.4 Rhodium Ø 22 mm Front surface
Plane		
1523 Fig.6 Ø 26 mm	1524 Fig.5 Ø 24 mm	1525 Fig.4 Ø 22 mm
With cone - socket		
1526 Fig.6 Ø 26 mm	1527 Fig.5 Ø 24 mm	1528 Fig.4 Ø 22 mm

1512  
Hollow Handle  
Fig.1

1513  
Hollow Handle  
Fig.2





**MOSSIDENT**  
Dental Surgical Instruments Supplier

Surgery Instruments  
instrumentos de cirugia  
instruments de chirurgie  
ascensori per radici  
أدوات الجراحة



**MIRROR HANDLES & MOUTH MIRRORS**



1529



1530



1531



1532



1533



1534



1535  
Parallelometer  
mouth mirror

1536  
Parallelometer  
mouth mirror  
+ handle  
code 2101



1537  
Tactile Tone  
Single Ended



1538  
Handle  
Thompson  
Single Ended



1539  
Hollow Handle



1540  
Hollow Handle  
Stainless  
Steel



1541  
Cone-socket  
Hollow Handle



1542  
Hollow Handle



1543  
Hollow Handle



# MOSSIDENT

Dental Surgical Instruments Supplier

Surgery Instruments  
instrumentos de cirugia  
instruments de chirurgie  
ascensori per radici  
أدوات الجراحة



## SCALERS

### SCALERS - JAQUETTE

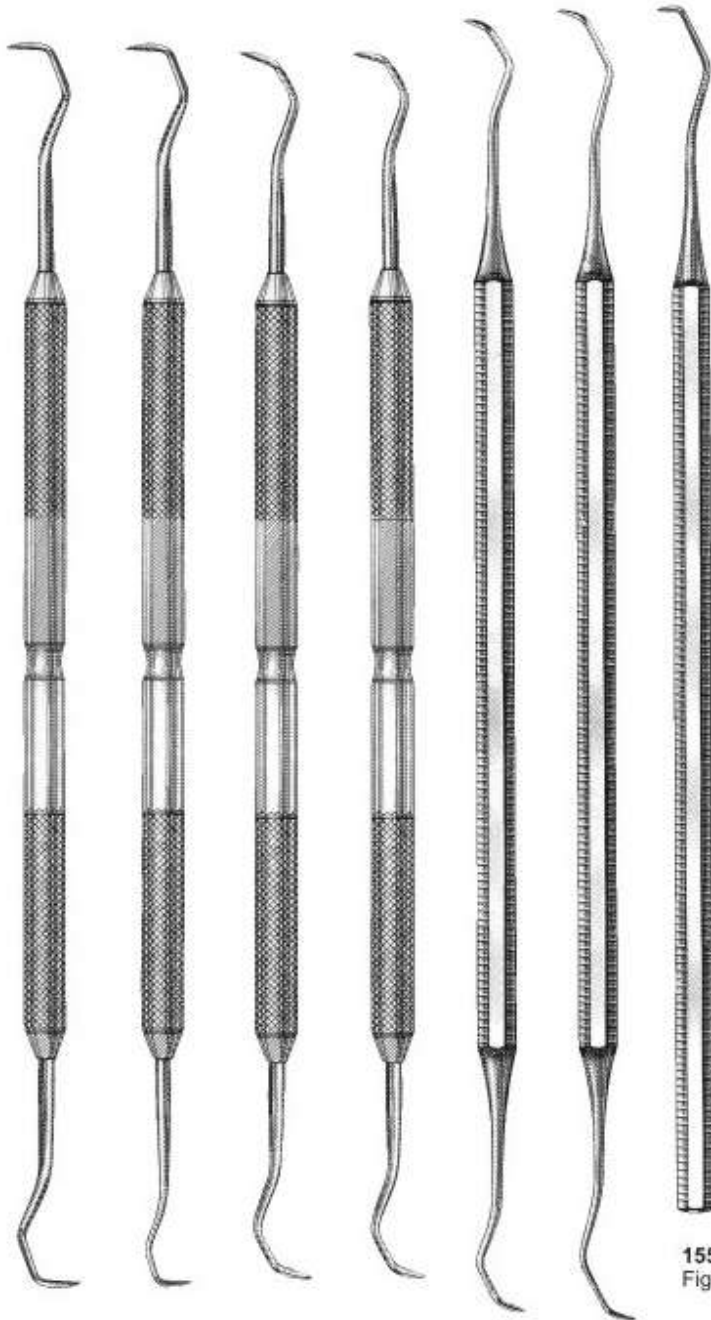

1544  
1Y-1Y

1545  
1Y-1YS

1546  
2Y-3Y

1547  
2YS-3YS

1548  
2-3

1549  
2S-3S

1550  
Fig.1

### SCALERS - OCTAGONAL

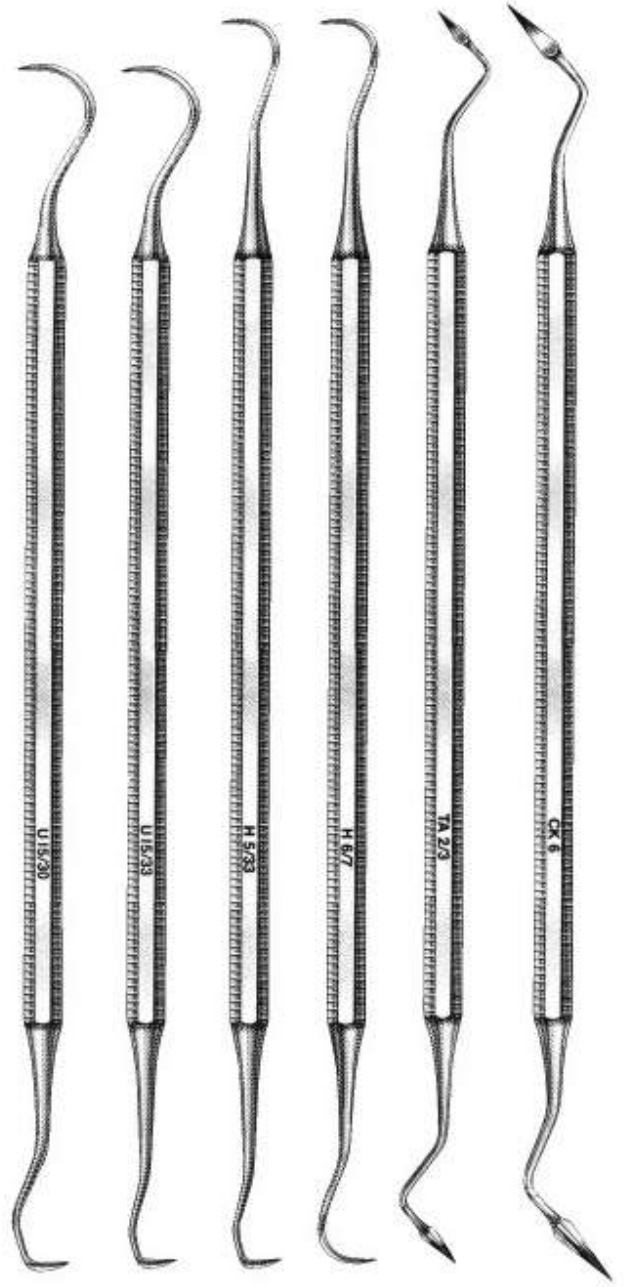

1551  
U15-30

1552  
U15-33

1553  
H5-33

1554  
H6-7

1555  
Taylor 2-3

1556  
CK6



**MOSSIDENT**

Dental Surgical Instruments Supplier

Surgery Instruments  
instrumentos de cirugía  
instruments de chirurgie  
ascensori per radici  
أدوات الجراحة



## SCALERS



**1557**  
U15



**1558**  
No. 3



**1559**  
No. 12



**1560**  
WHITESIDE 1-0

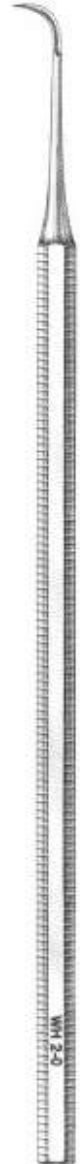

**1561**  
WHITESIDE 2-0



**MOSSIDENT**  
Dental Surgical Instruments Supplier

Surgery Instruments  
instrumentos de cirugia  
instruments de chirurgie  
ascensori per radici  
أدوات الجراحة



## SCALERS



**1562**  
YAOUNGER/GOOD  
7-8



**1563**  
H5-33



**1564**  
204SD



**1565**  
H6-7



**1566**  
204S



**1567**  
TOWNER/JAQUETTE  
U15-30





## SCALERS



**1568**  
JAQUETTE (33-U15)



**1569**  
JAQUETTE  
2Y-3Y



**1570**  
JAQUETTE  
30-U15



**1571**  
JAQUETTE  
2YS-3YS



**1572**  
JAQUETTE  
33-H5



**1573**  
YOUNGER/GOOD  
7-8



**1574**  
204S



**1575**  
204SD



**1576**  
H6-7

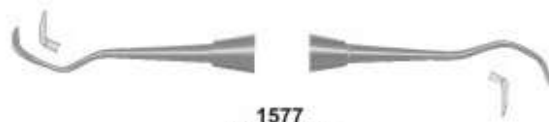

**1577**  
JAQUETTE  
2S-3S



**1578**  
JAQUETTE  
1Y-1YS



**1579**  
JAQUETTE  
2-3



# MOSSIDENT

Dental Surgical Instruments Supplier

Surgery Instruments  
instrumentos de cirugia  
instruments de chirurgie  
ascensori per radici  
أدوات الجراحة



## SCALERS

## ENGLISH PATTERN



**1580**  
JAQUETTE (33-U15)



**1581**  
S204



**1582**  
Jack-Nebraska



**1583**  
S204S

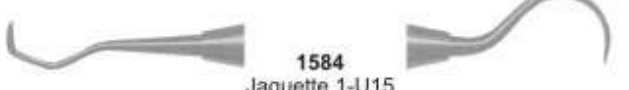

**1584**  
Jaquette 1-U15



**1585**  
S204SD



**1586**  
Jaquette 2-3



**1587**  
Goldman 6-7



**1588**  
Jaquette 2S-3S



**1589**  
Goldman Fox 21



**1590**  
Jaquette 30-U15



**1591**  
H5-U15



**1592**  
Jaquette 30-33



**1593**  
Jaquette 34-35



**1594**  
Jaquette 31-32



**1595**  
Thompson Jr.



**1596**  
Jaquette 33-H5



**1597**  
UT107-108



**1598**  
U 6-7



**1599**  
UP128



**1600**  
128L



# MOSSIDENT

Dental Surgical Instruments Supplier

Surgery Instruments  
instrumentos de cirugia  
instruments de chirurgie  
ascensori per radici  
أدوات الجراحة



## EXPLORERS

### Explorers Double Ended - Octagonal

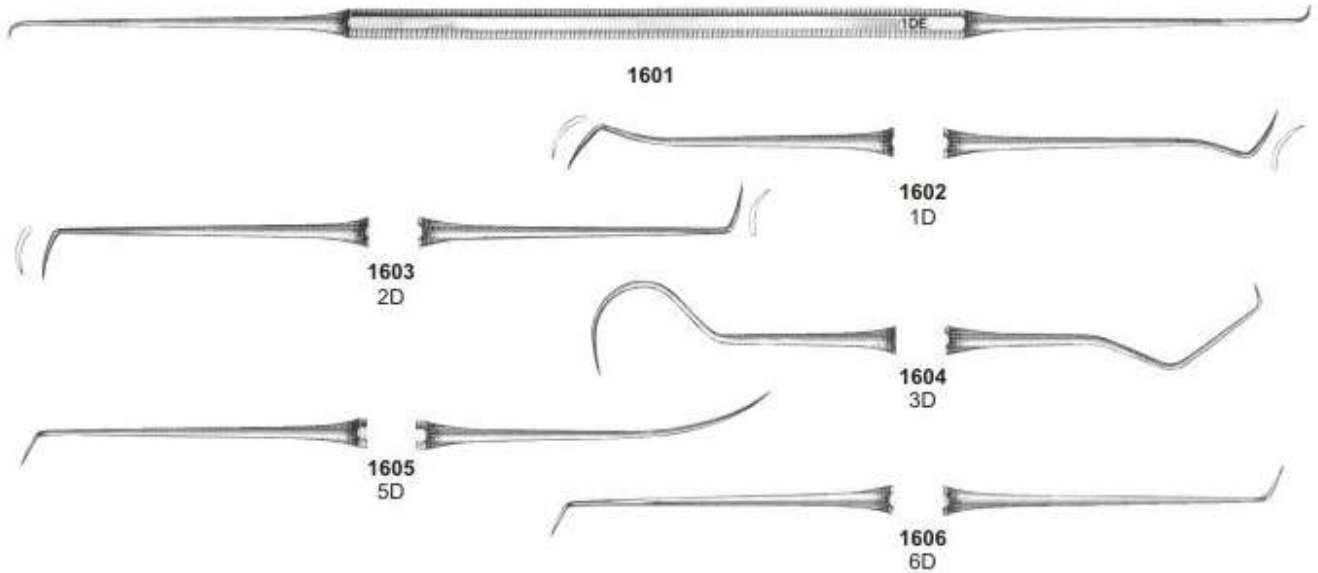

### Explorers Double Ended - Standard

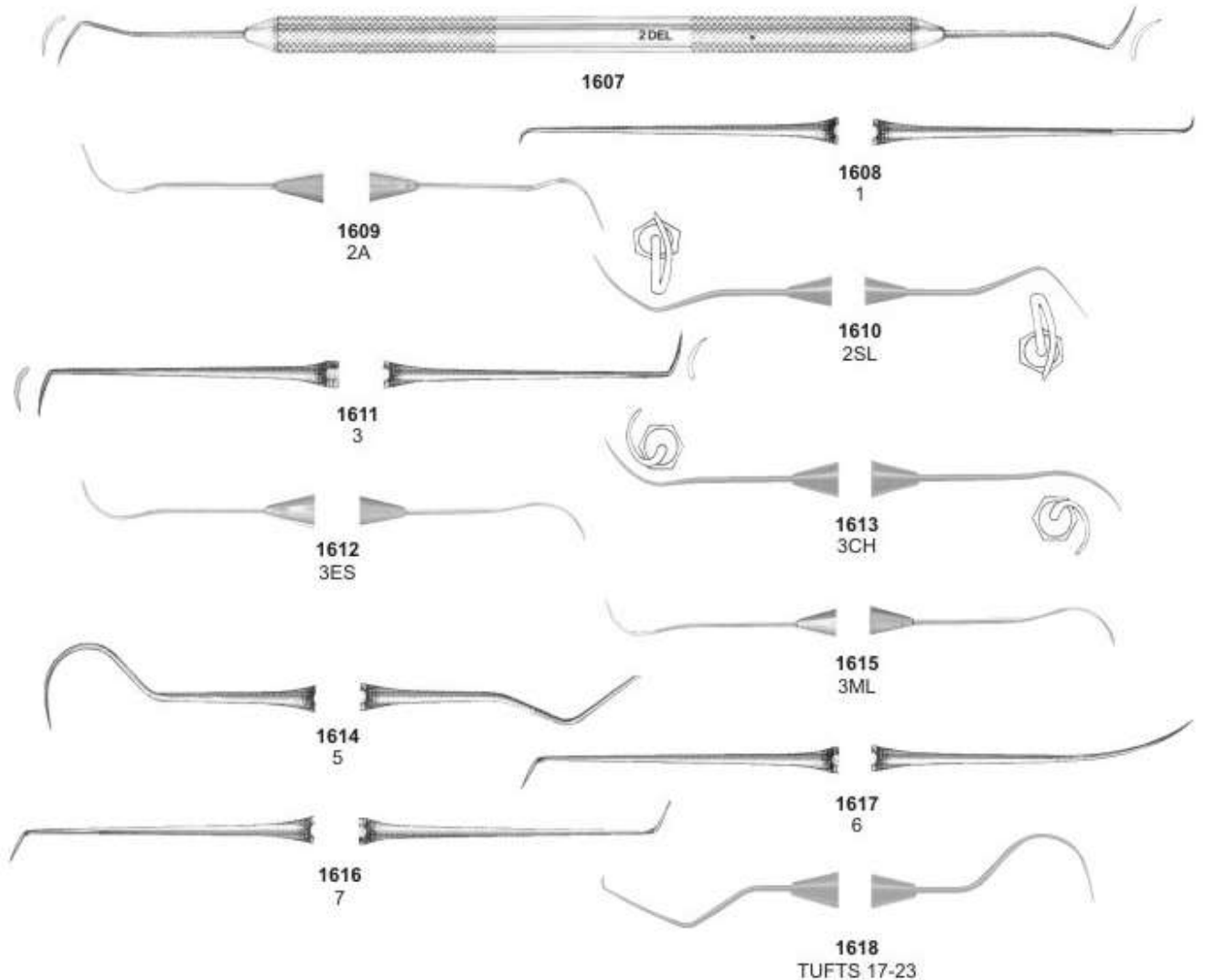



## EXPLORERS

### Explorers Double Ended Tactile Tone



1619  
2A



1620  
2



1621  
1



1622  
2SL



1623  
3



1624  
3CH



1625  
3ES



1626  
3ML



1627  
5



1628  
6



1629  
7



1630  
16



1631  
TUFTS 17/23





## EXPLORERS & PROBES

### Explorers Single Ended - Octagonal

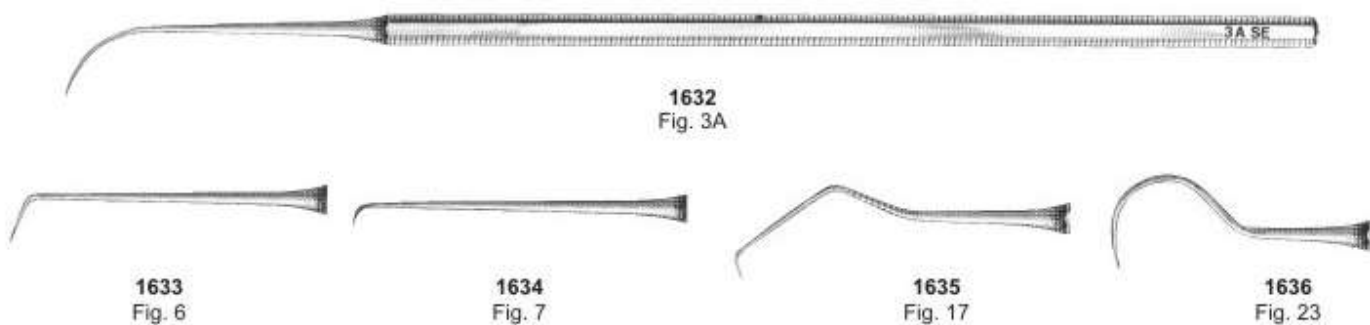

### Explorers Single Ended - Standard

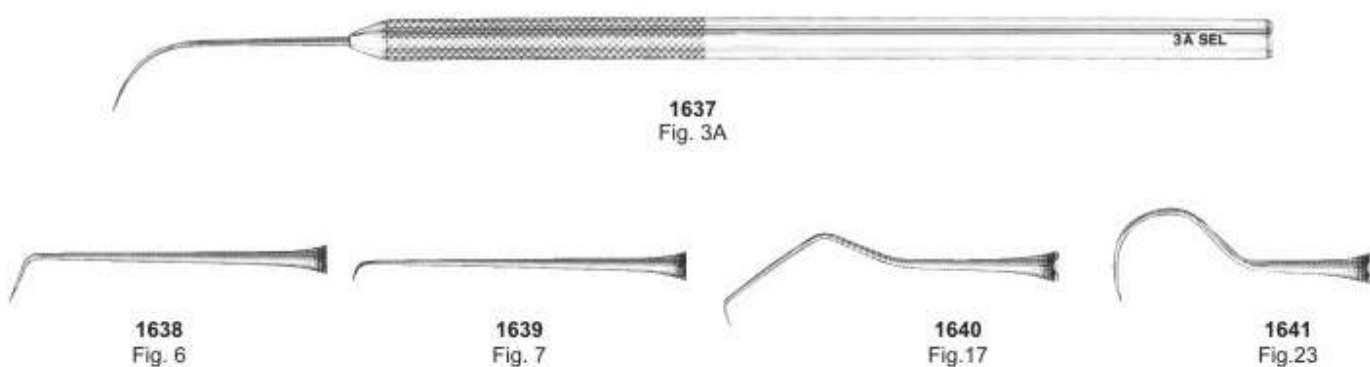

### Probe / Explorer - Octagonal



### Double Ended Probe - Octagonal





## PROBES

### Probes Double Ended - Standard

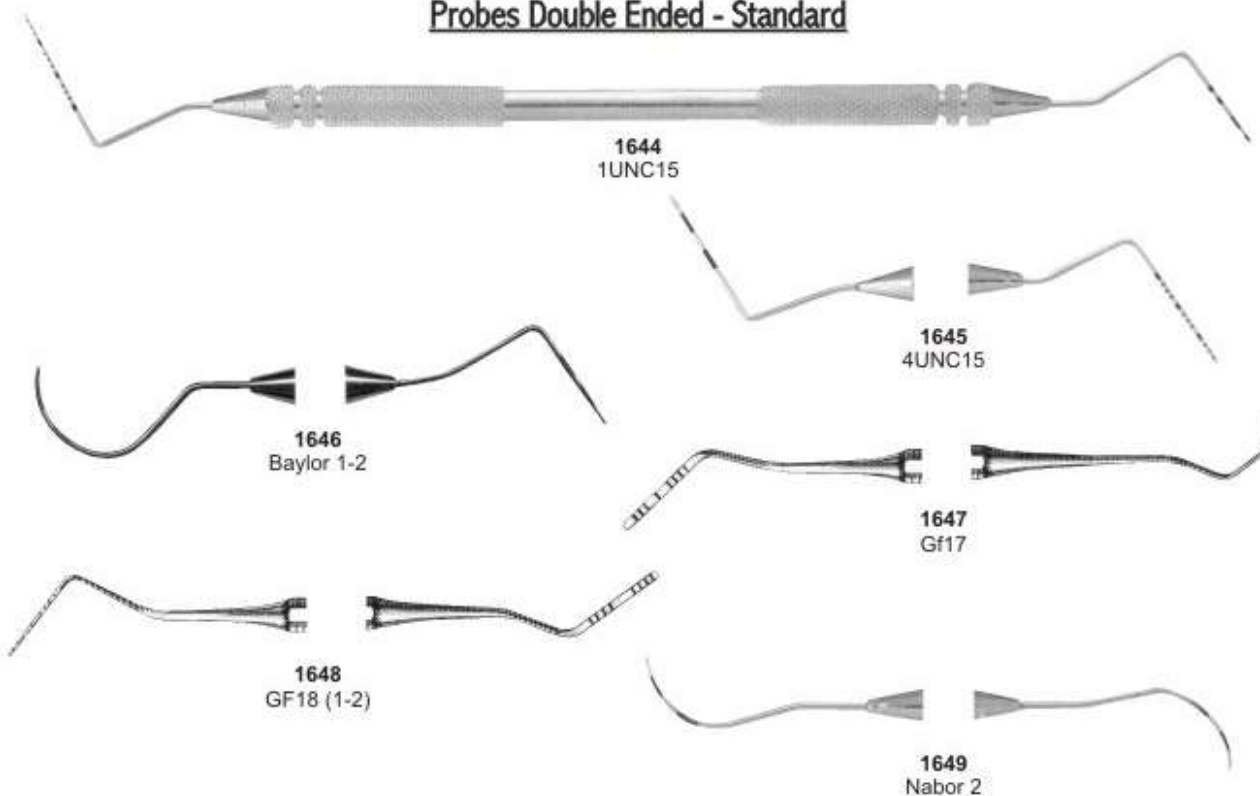

### Probes Double Ended - Tactile Tone

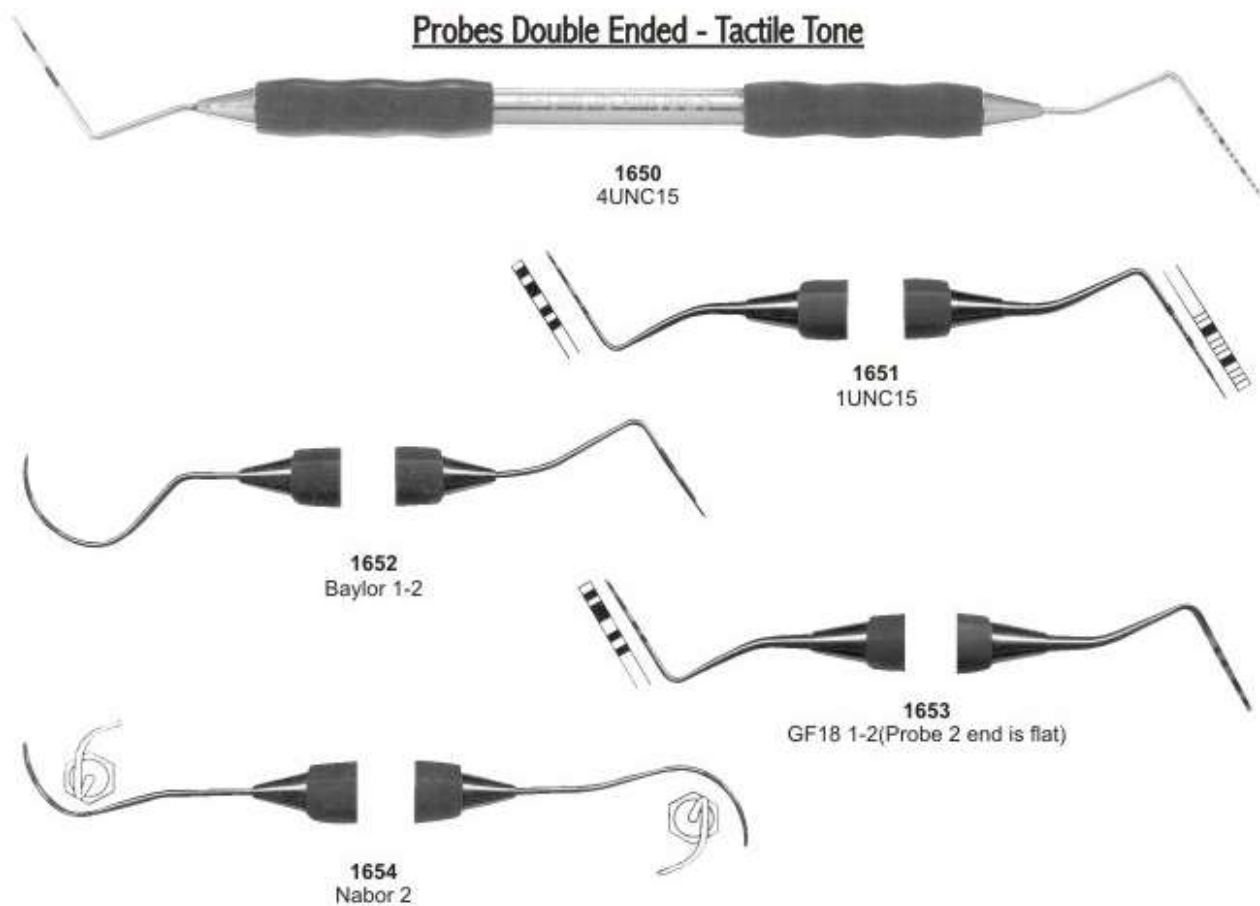



**PROBES**

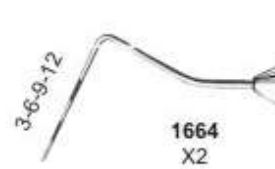
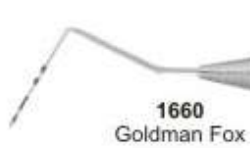
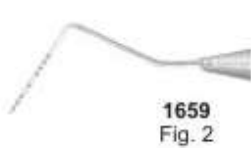
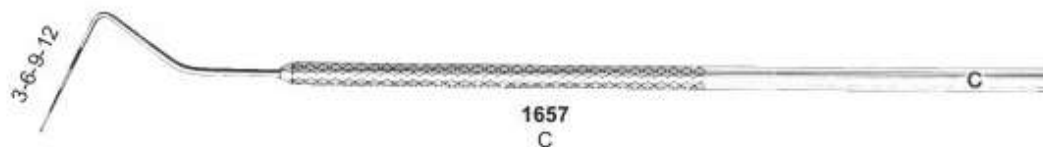
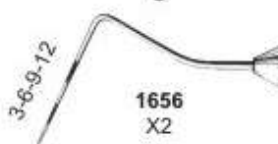
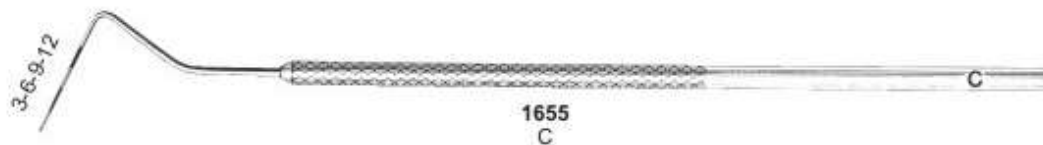



**PROBES**

**PROBES DOUBLE ENDED STANDARD**

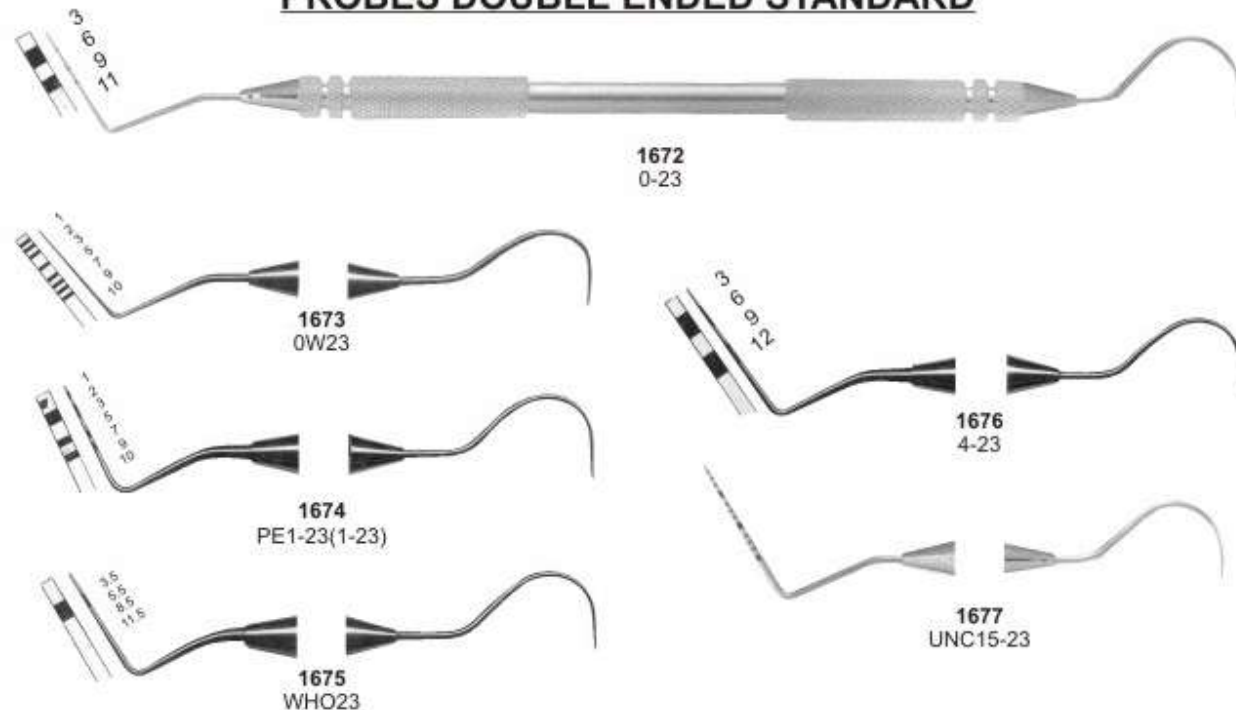

**PROBES DOUBLE ENDED TACTILE TONE**

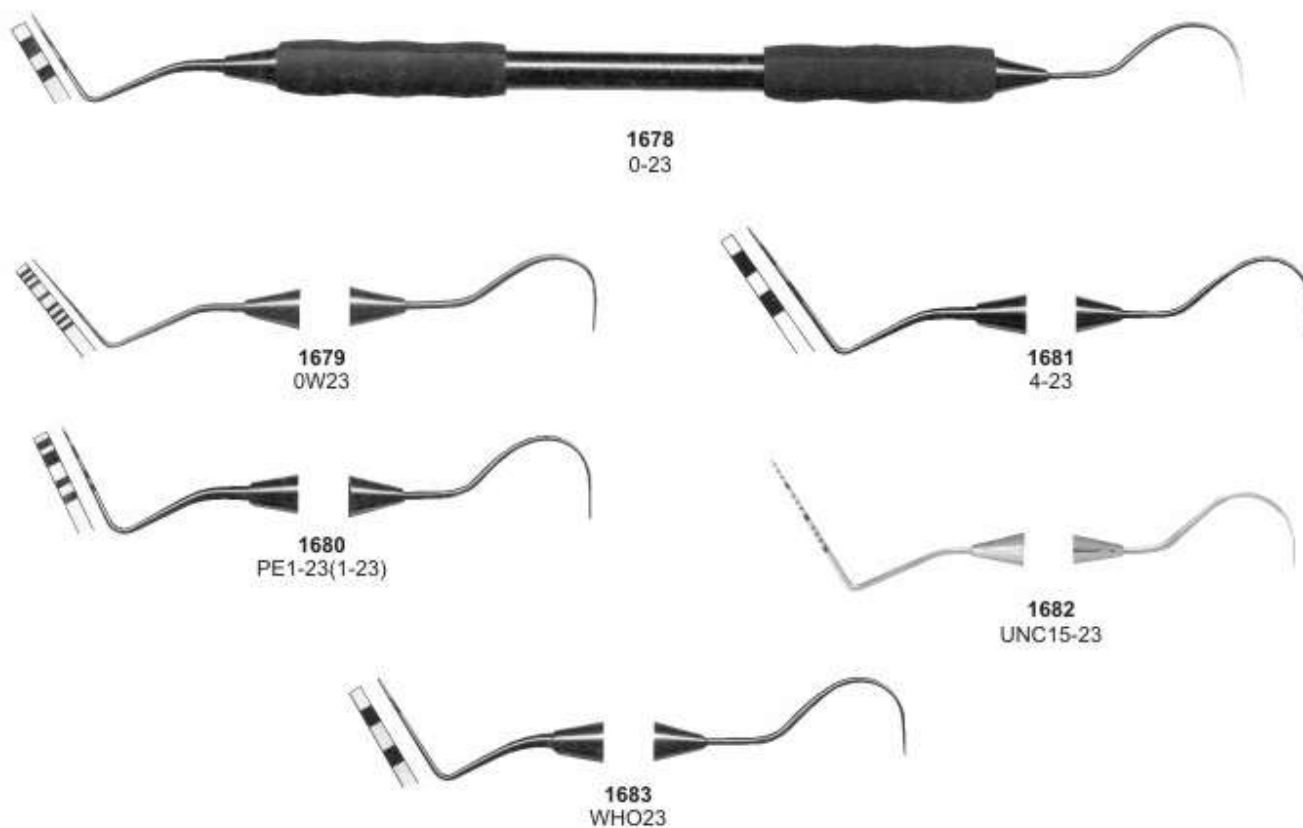





**MOSSIDENT**  
Dental Surgical Instruments Supplier

Surgery Instruments  
instrumentos de cirugia  
instruments de chirurgie  
ascensori per radici  
أدوات الجراحة



## ENDODONTIC CONDENSERS



**1684**  
TF13 Root Canal 1-3



**1685**  
TF57 Root Canal 5-7

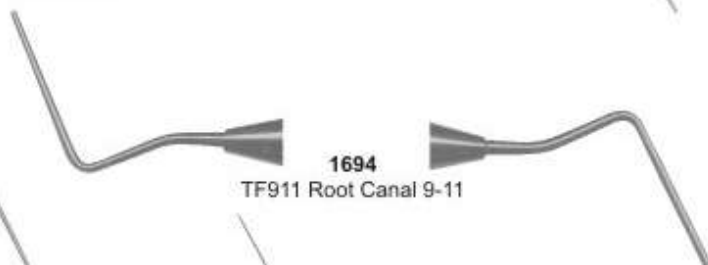

**1694**  
TF911 Root Canal 9-11



**1686**  
UF30 \*ISO-30



**1695**  
UF35 \*ISO-35



**1687**  
UF40 \*ISO-40 (8)



**1696**  
UF45 \*ISO-45



**1688**  
UF50 \*ISO-50 (7)

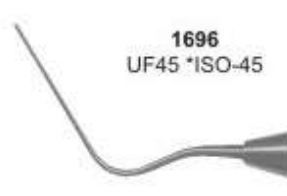

**1697**  
UF55 \*ISO-55 (9)



**1689**  
UF65 \*ISO-65



**1693**  
UF60 \*ISO-60



**1698**  
UF70 \*ISO-70



**1690**  
UF80 \*ISO-80



**1699**  
UF85 \*ISO-85



**1691**  
UF90 \*ISO-90



**1700**  
UF100 \*ISO-100



**1692**  
UF110 \*ISO-110

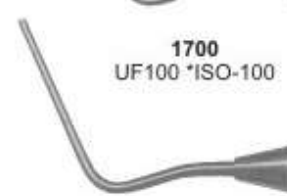

**1701**  
UF110 \*ISO-130



# MOSSIDENT

Dental Surgical Instruments Supplier

Surgery Instruments  
instrumentos de cirugia  
instruments de chirurgie  
ascensori per radici  
أدوات الجراحة



## ENDODONTIC CONDENSERS/ SPREADERS



**1702**  
UF120X



**1703**  
UF45N



**1704**  
UF60N



**1705**  
UF80N



**1706**  
UF100X



**1707**  
UE25 R-25



**1708**  
UE30 R-30



**1709**  
UE35 R-35



**1710**  
UE40 R-40



**1711**  
UE45 R-45



**1712**  
UE50 R-50



**1713**  
UF120X



**1714**  
UF140X

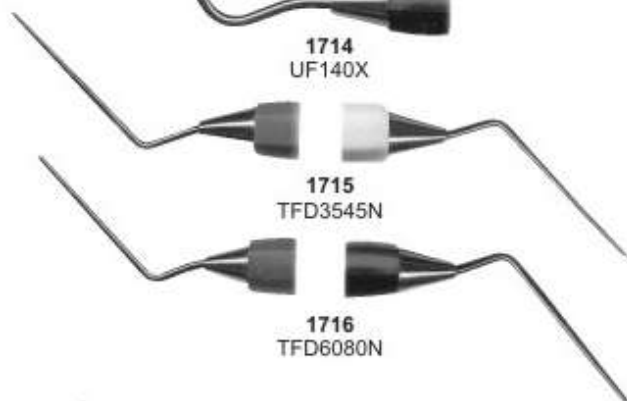

**1715**  
TFD3545N

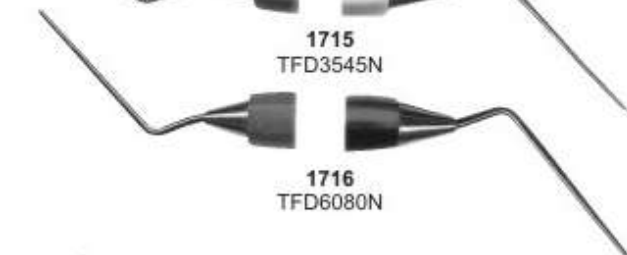

**1716**  
TFD6080N



**1717**  
UE55 R-55

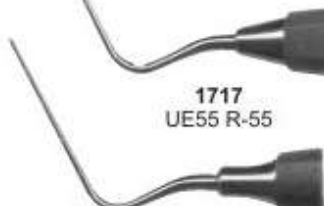

**1718**  
UE60 R-60



**1719**  
UE25N R-25



**1720**  
UE30N R-30



**1721**  
UE40N R-40



**OBTURATION INSTRUMENTS**

**1722**  
No. D11



**1723**  
No. D11T



**1724**  
No. KR1



**1725**  
No. 25S

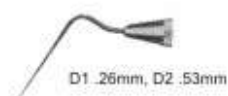

**1726**  
No. W1S



**1727**  
No. W2S

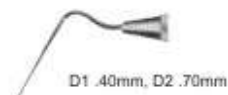

**1728**  
Lucks No.1



**1729**  
Lucks No.2



**1730**  
Lucks No.3



**1731**  
Lucks No.4

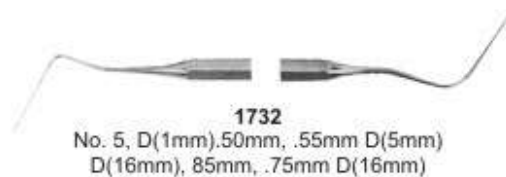

**1732**  
No. 5, D(1mm), 50mm, .55mm D(5mm)  
D(16mm), 85mm, .75mm D(16mm)

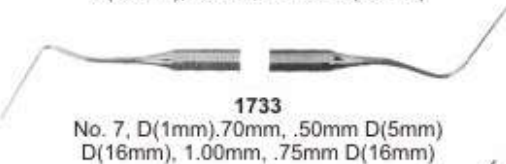

**1733**  
No. 7, D(1mm), 70mm, .50mm D(5mm)  
D(16mm), 1.00mm, .75mm D(16mm)



**1734**  
No. 9, D(1mm) 1.00mm, .63mm D(5mm)  
D(16mm), 1.30mm, .75mm D(16mm)

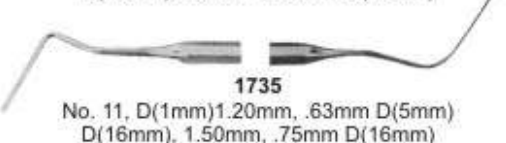

**1735**  
No. 11, D(1mm) 1.20mm, .63mm D(5mm)  
D(16mm), 1.50mm, .75mm D(16mm)



**1736**  
No.1 (D1 .35mm, D16 .75mm)



**1737**  
No.2 D1 .55mm, D16 .85mm



**1738**  
No.3 D1 .85mm, D16 1.15mm



**1739**  
No.4 D1 1.00mm, D16 1.30mm



**1740**  
No.1-3 - D1 .25mm/D1 .35mm



**1741**  
No.3-5 - D1 .35mm/D1 .55mm



**1742**  
No.5-7 - D1 .55mm/D1 .70mm



**1743**  
No.9-11 - D1 1.00mm/D1 1.20mm



# MOSSIDENT

Dental Surgical Instruments Supplier

Surgery Instruments  
instrumentos de cirugia  
instruments de chirurgie  
ascensori per radici  
أدوات الجراحة



## EXAVATORS

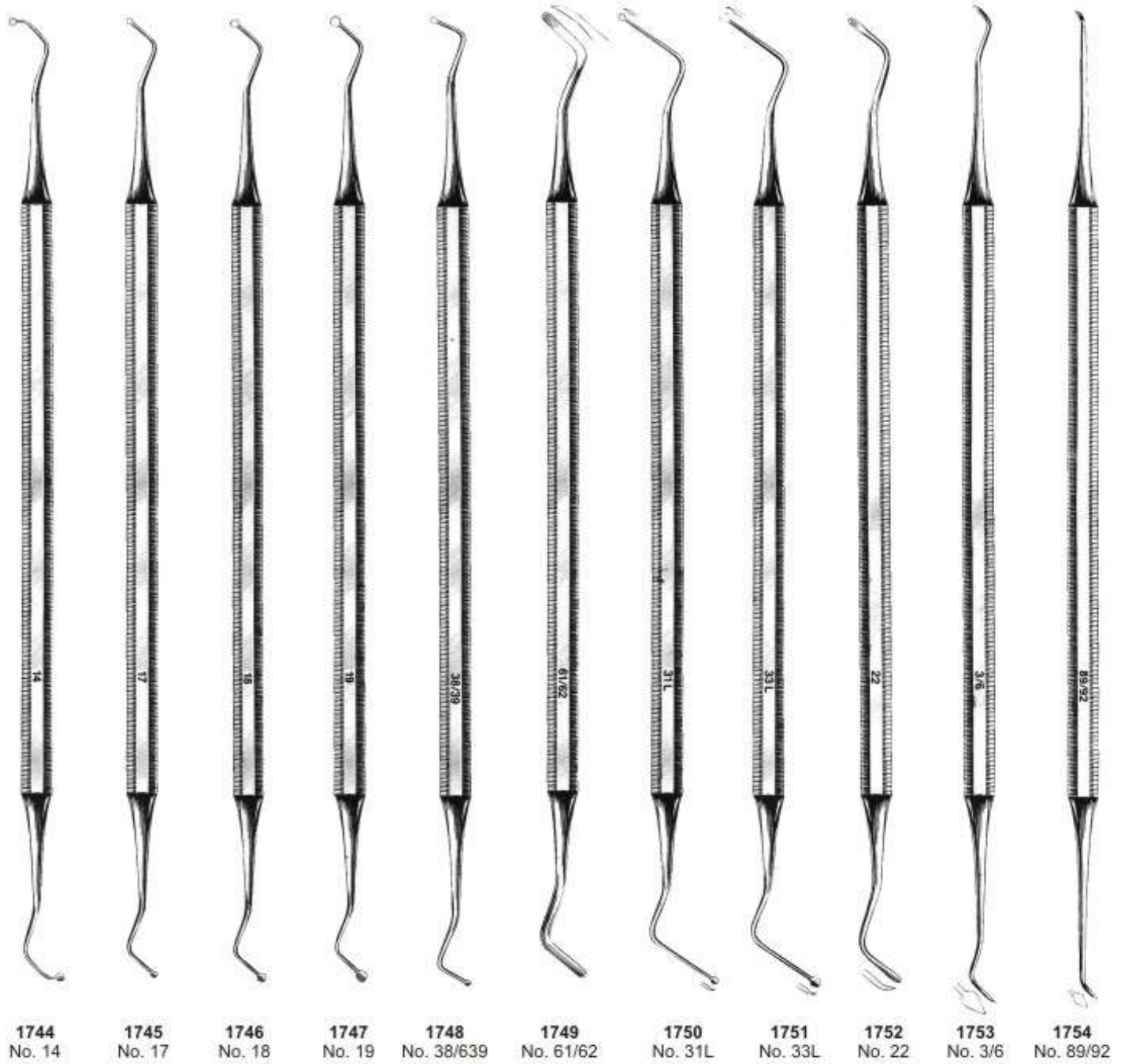

1744  
No. 14

1745  
No. 17

1746  
No. 18

1747  
No. 19

1748  
No. 38/39

1749  
No. 61/62

1750  
No. 31L

1751  
No. 33L

1752  
No. 22

1753  
No. 3/6

1754  
No. 89/92





## EXAVATORS

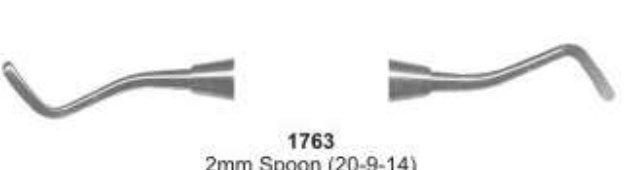
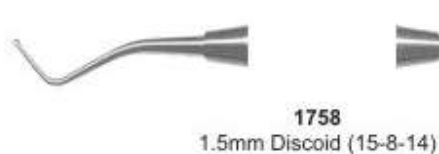



**EXAVATORS / EXPLORERS/ PROBES**

**Excavators**

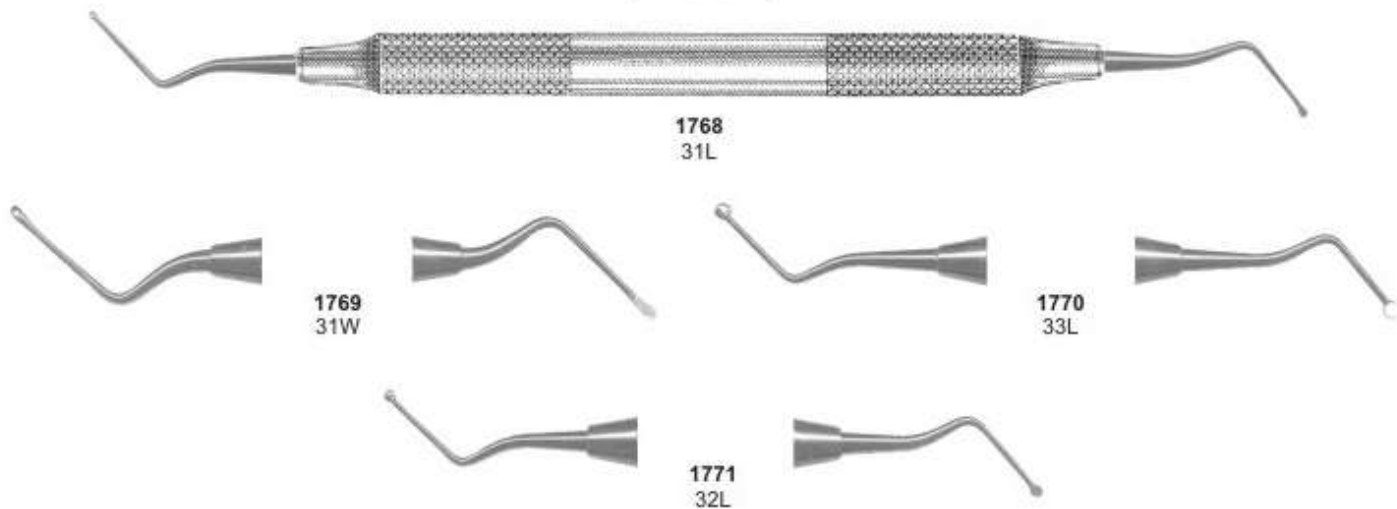

**Explorers / Probes**

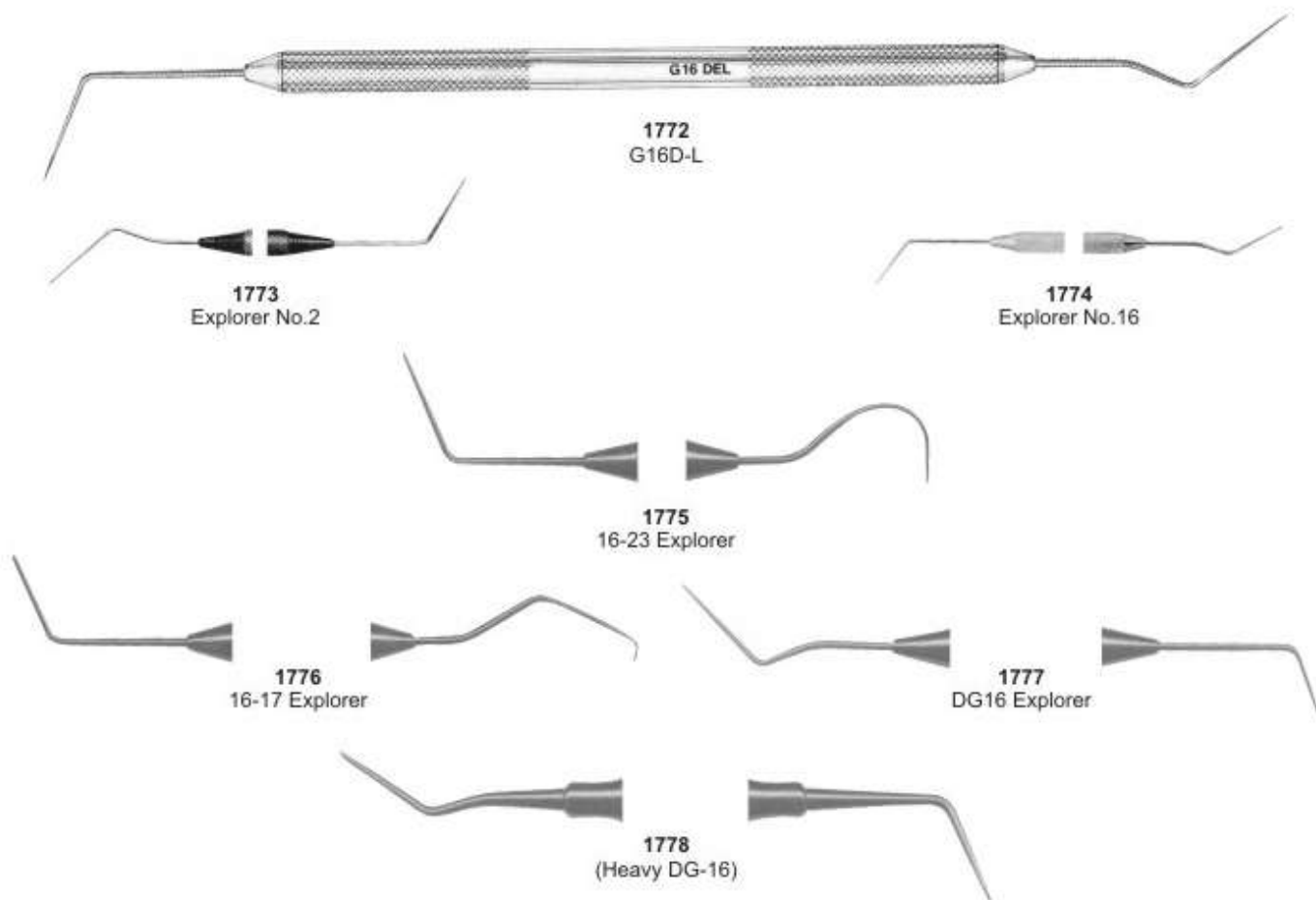



**MOSSIDENT**  
Dental Surgical Instruments Supplier

Surgery Instruments  
instrumentos de cirugia  
instruments de chirurgie  
ascensori per radici  
أدوات الجراحة



## EXPLORERS



1779  
1D

1780  
2D

1781  
3D

1782  
5D

1783  
6D

1784  
7D

1785  
3A-S

1786  
6S

1787  
7S

1788  
17S

1789  
23S



# MOSSIDENT

Dental Surgical Instruments Supplier

Surgery Instruments  
instrumentos de cirugia  
instruments de chirurgie  
ascensori per radici  
أدوات الجراحة



## EXPLORERS



**1790**  
No. 2D-L



**1791**  
No. 3D-L



**1792**  
No. 3CHD-L



**1793**  
No. 5D-L



**1794**  
No. G16D-L



**1795**  
No. 3A SEL



**1796**  
No. 6S-L



**1797**  
No. 17S-L



**1798**  
No. 23S-L





**EXPLORERS/ PROBE COMBINATION**

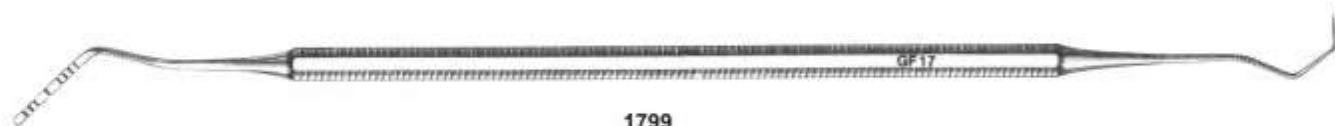

**1799**  
Gf17 Probe/Explorer



**1800**  
PE 1-23 Probe/Explorer

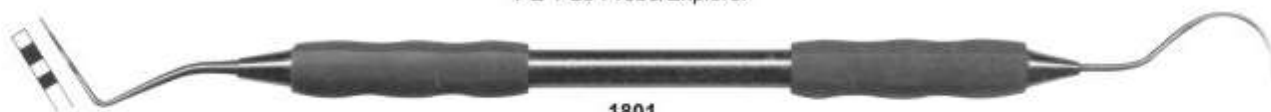

**1801**  
Probe 0 / 23 Explorer (fine)



**1802**  
Probe 1 / 23 Explorer



**1804**  
Probe 4 / 23 Explorer



**1803**  
Probe OW / 23 Explorer



**1805**  
Ball Tip Probe WHO / 23 Explorer

**PROBES**



**1806**  
Gf18 Probe



**1807**  
'C' Probe



**1808**  
X2 Probe



**1809**  
1-2 (Probe 2 end is flat)



**1810**  
1 UNC 15



**1811**  
4 SE



# MOSSIDENT

Dental Surgical Instruments Supplier

Surgery Instruments  
instrumentos de cirugia  
instruments de chirurgie  
ascensori per radici  
أدوات الجراحة



## CORD PACKERS/ HATCHETS/ HOES

### CORD PACKERS

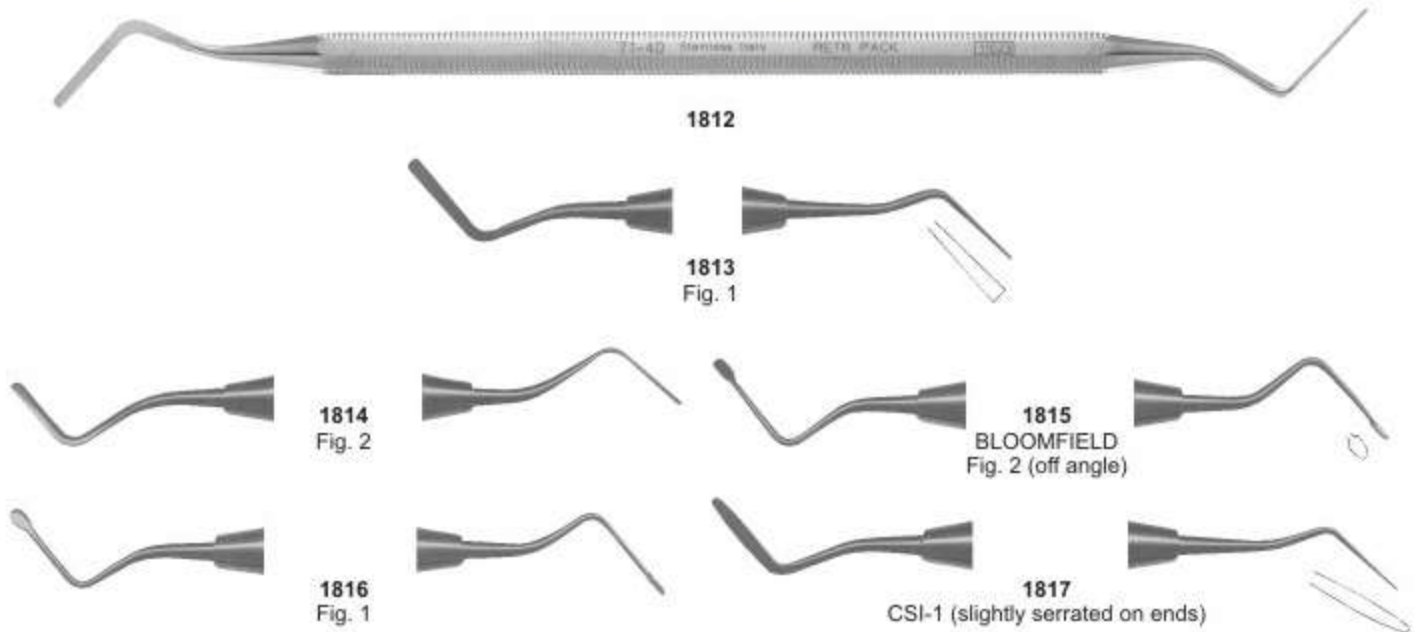

### HATCHETS

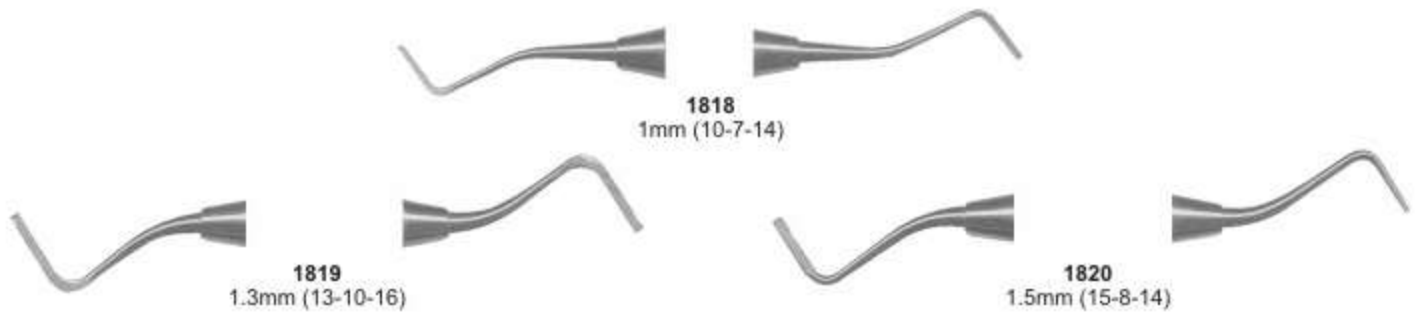

### HOES

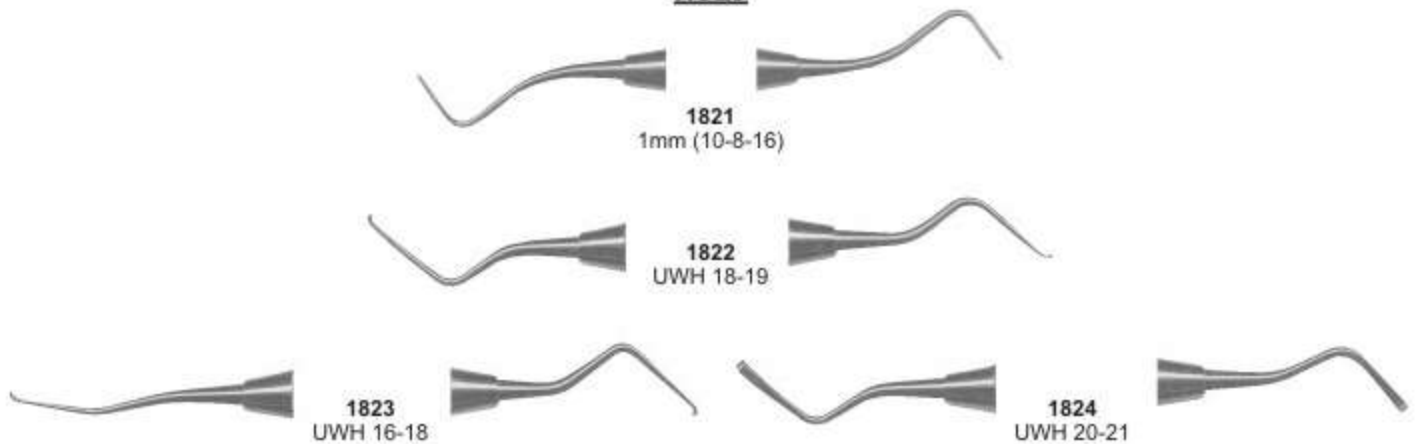



# MOSSIDENT

Dental Surgical Instruments Supplier

Surgery Instruments  
instrumentos de cirugia  
instruments de chirurgie  
ascensori per radici  
أدوات الجراحة



## P.K THOMAS / GRACEY SET



**1825**  
P.K.Thomas 1



**1826**  
P.K.Thomas 2



**1827**  
P.K.Thomas 3



**1828**  
P.K.Thomas 4



**1829**  
P.K.Thomas 5



**7001**  
Gracey Curettes Set of 7 Pcs, Silicon Handle - Reuseable



**AMALGAM PLUGGERS/ CONDENSERS/ APPLICATORS**



**1830**  
BEHRMAN (Fig. 1)



**1831**  
BLACK (Fig. 1-2)



**1834**  
Hollenback No.1 Plugger



**1832**  
MORQUETTE (Fig. 0/1)



**1835**  
Hollenback No. 2 Plugger



**1833**  
Black Action 11/12 Plugger

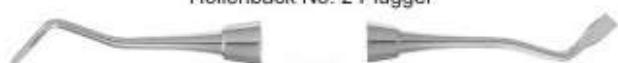

**1836**  
Hollenback No. 3 Plugger



**1837**  
Blacks 0-1 (1mm-1.5mm)



**1838**  
Blacks 1-2 (1.5mm-2.5mm)



**1843**  
.7mm-1mm



**1839**  
Bodkin 1 (.7mm-1mm)

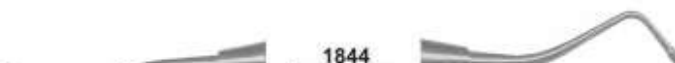

**1844**  
1mm-1.5mm

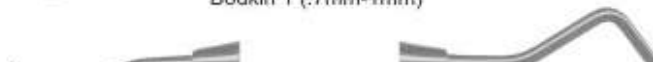

**1840**  
Bodkin 2 (1.5mm-2mm)



**1845**  
1.5mm-2mm



**1841**  
2.5mm-3mm

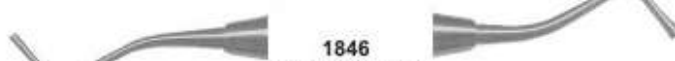

**1846**  
Oregon (Fig. 3)



**1842**  
Oregon 2



**1847**  
Oregon (Fig. 4)



**1848**  
UP 12



**1849**  
Applicator 1-2



**1850**  
Birtles Applicator Spatula



**1851**  
Birtles Applicator Spatula K





PLACEMENT INSTRUMENTS/ STOPPING STOPPERS/ PLUGGERS

Placement Instruments



**1852**  
PICH (Calcium Hydroxide Placer)



**1853**  
CA

Stopping Stoppers



**1854**  
Woodson 2

Ø 1.6 mm



**1855**  
Woodson 3S

Ø 2.4 mm

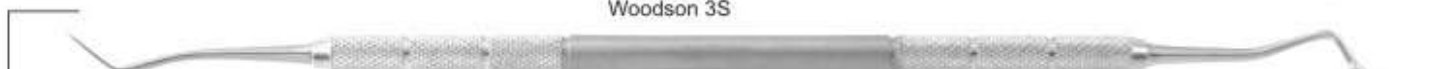

**1856**  
Woodson 3A

Ø 2.6 mm



**1857**  
Woodson 3

Ø 3.0 mm

Pluggers



**1858**  
Pluggers 0-1

Ø 1.2 mm



**1859**  
Pluggers 1-4

Ø 1.6 mm



**1860**  
Pluggers 4-6

Ø 2.0 mm



**1861**  
Pluggers 6-8

Ø 2.5 mm

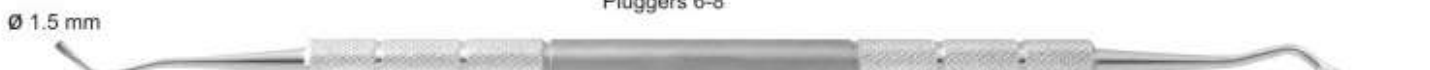

**1862**  
Black 1-2

Ø 2.6 mm

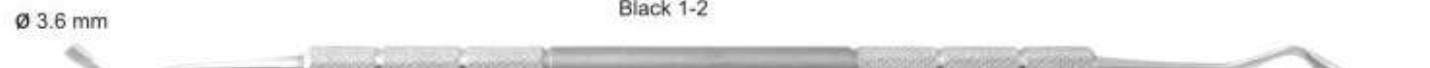

**1863**  
Black 2-3

Ø 5.0 mm



**MOSSIDENT**

Dental Surgical Instruments Supplier

Surgery Instruments  
instrumentos de cirugia  
instruments de chirurgie  
ascensori per radici  
أدوات الجراحة



## BURNISHERS

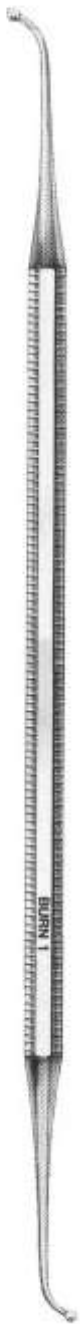

1864  
Fig. 1



1865  
Fig. 28/29



1866  
Fig. 34

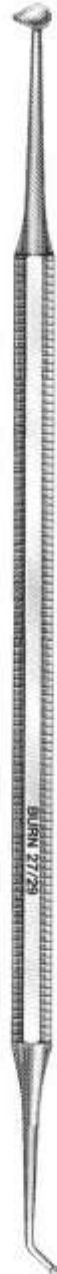

1867  
Fig. 27/29



1868  
Fig. 21B



1869  
ACORN  
Fig. 21



**BURNISHERS**





# MOSSIDENT

Dental Surgical Instruments Supplier

Surgery Instruments  
instrumentos de cirugia  
instruments de chirurgie  
ascensori per radici  
أدوات الجراحة



## WAX CARVERS

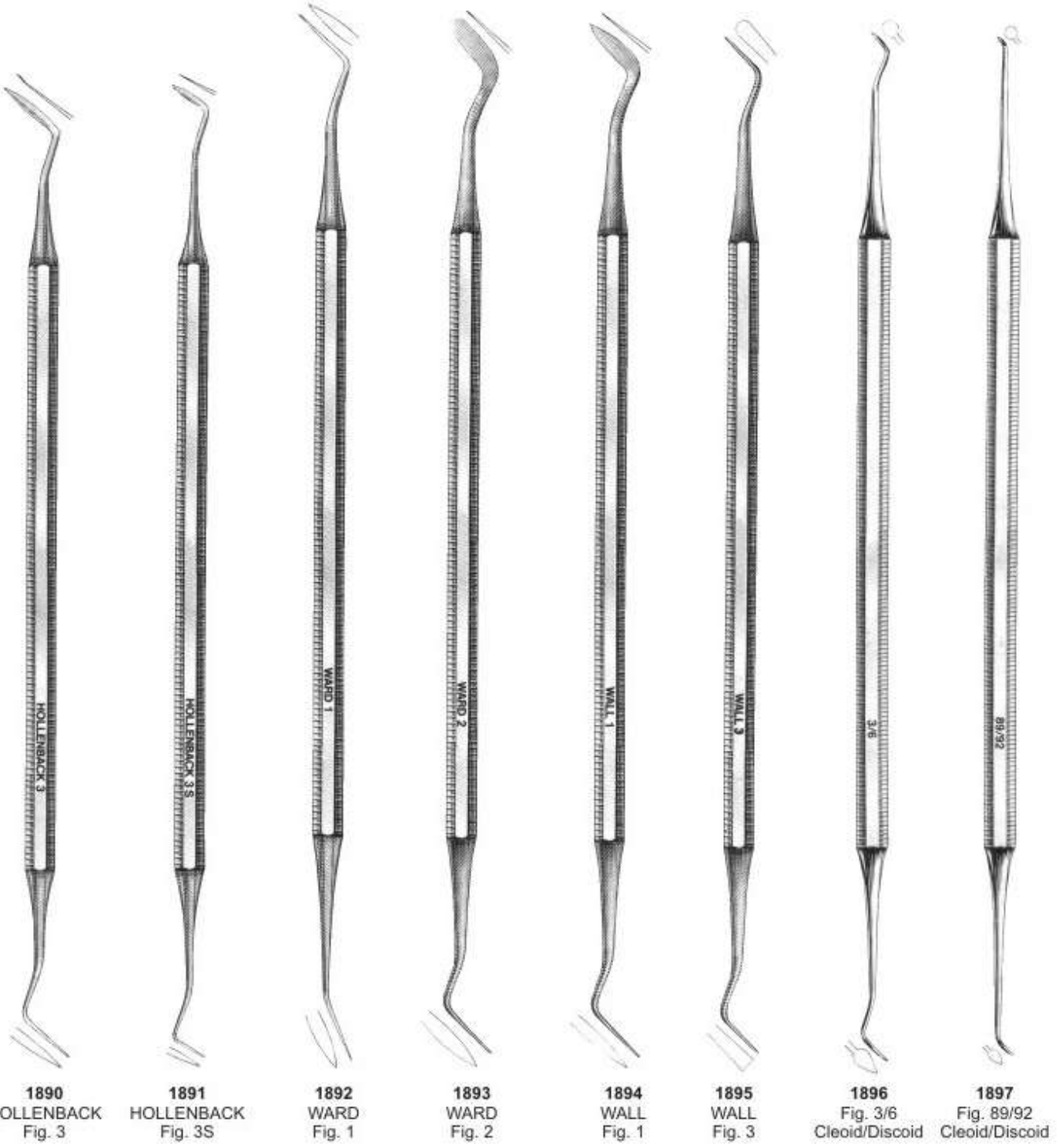





# MOSSIDENT

Dental Surgical Instruments Supplier

Surgery Instruments  
instrumentos de cirugia  
instruments de chirurgie  
ascensori per radici  
أدوات الجراحة



## CARVERS



**1898**  
1.5mm Cleoid Discoid (Shown with GTX Finish)



**1899**  
2mm Cleoid Discoid



**1900**  
GOLLOBIN  
Fig. 1



**1901**  
3mm Cleoid Discoid



**1902**  
HOLLENBACK  
Fig. 1/2



**1903**  
FRAHM  
Fig. 2-3 (off-angle)



**1904**  
HOLLENBACK  
Fig. 3



**1905**  
Interproximal 1



**1906**  
THOMPSON (Fig. 3)  
(½ Hollenback Hoe & Wall 3)



**1907**  
Interproximal 1



**1908**  
THOMPSON (Fig. 5)  
(½ Hollenback Hoe & Tanner 5)



**1909**  
Baum Interproximal



**1910**  
THOMPSON (Fig. 8)  
(3mm Cleoid & Wall 3)



**1911**  
Sho A Carver



**1912**  
THOMPSON (Fig. 9)  
(Hollenback 3 & Wall 3)



**1913**  
Thompson 2



**1914**  
WARD  
Fig. 2





# MOSSIDENT

Dental Surgical Instruments Supplier

Surgery Instruments  
instrumentos de cirugia  
instruments de chirurgie  
ascensori per radici  
أدوات الجراحة



## CARVERS, CHIESELS



**1915**  
Composite Interproximal



**1916**  
TANNER  
Fig. 5



**1917**  
TANNER  
Fig. 6



**1918**  
THARP  
Fig. 1



**1919**  
THOMPSON  
Fig. 1



**1920**  
University of Minnesota  
Fig. 1



**1921**  
University of Minnesota  
Fig. 2



**1922**  
UPR  
Fig. 1



**1923**  
WALL  
Fig. 3

### Contour Carbide Carvers - Finishing



**1924**  
Contour Carbide (Fig. 1-2)



**1925**  
Cleoid Discoid

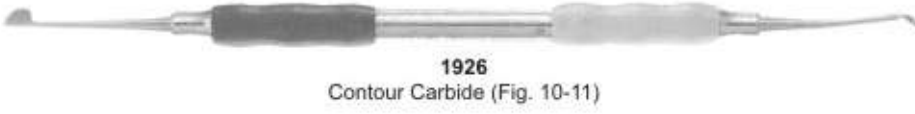

**1926**  
Contour Carbide (Fig. 10-11)

### Chisels



**1927**  
1.5mm Bin-Angle (15-8-8)



**1928**  
1.5mm Straight (15)



**1930**  
1.5mm Wedelstaedt (15-15-3)



**1929**  
1mm Wedelstaedt (10-15-3)



**1931**  
2mm Wedelstaedt (20-15-3)



# MOSSIDENT

Dental Surgical Instruments Supplier

Surgery Instruments  
instrumentos de cirugia  
instruments de chirurgie  
ascensori per radici  
أدوات الجراحة



## COMPOSITE PLACEMENT

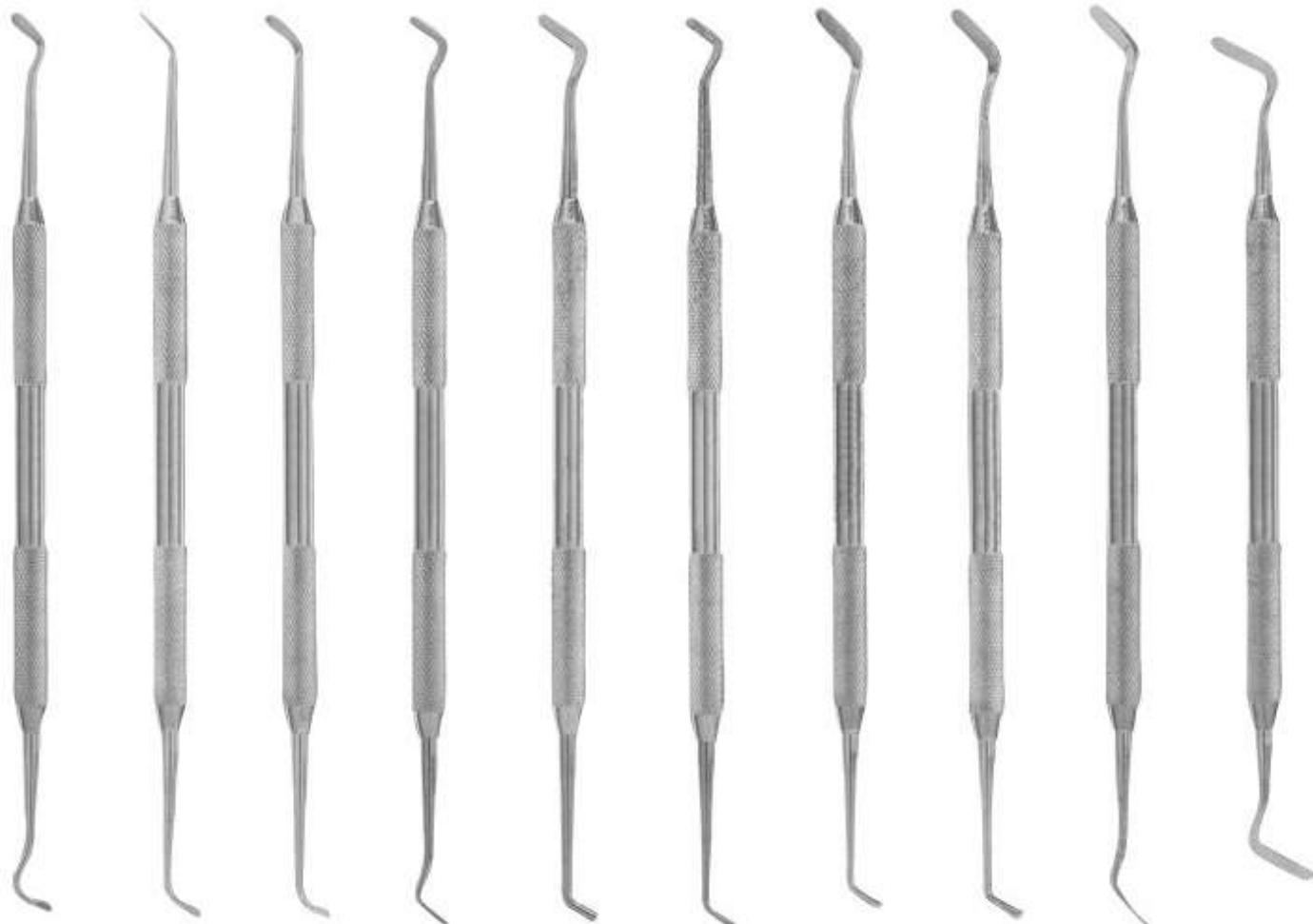

1932  
F-Type 1

1933  
F-Type 2

1934  
F-Type 3

1935  
F-Type 4

1936  
F-Type 5

1937  
F-Type 6

1938  
G-Type 1

1939  
G-Type 2

1940  
G-Type 3

1941  
G-Type 4



1942  
Fig. 1



1943  
Fig. 2



1944  
Fig. 3





# MOSSIDENT

Dental Surgical Instruments Supplier

Surgery Instruments  
instrumentos de cirugia  
instruments de chirurgie  
ascensori per radici  
أدوات الجراحة



## COMPOSITE PLACEMENT

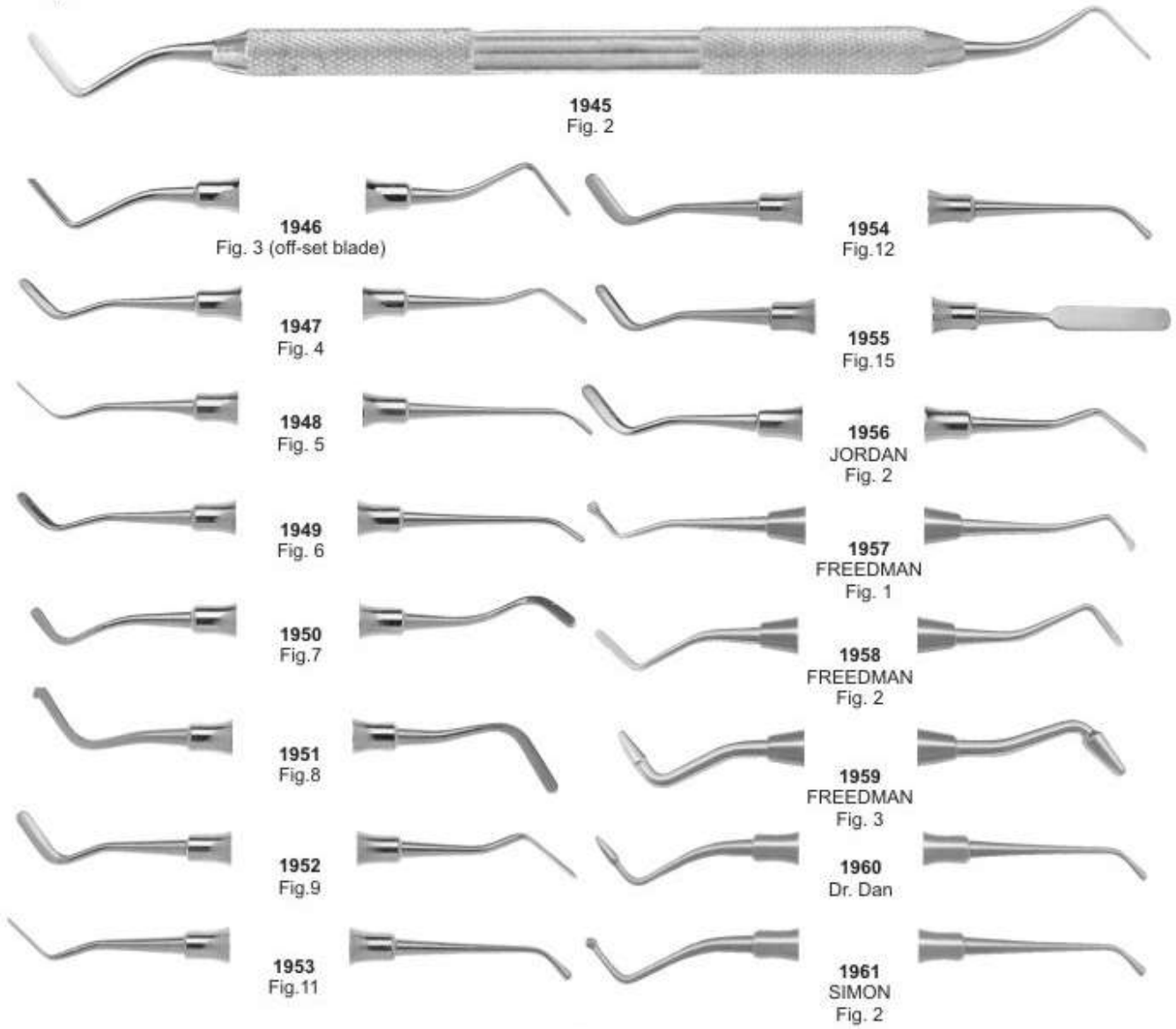

### K - Type

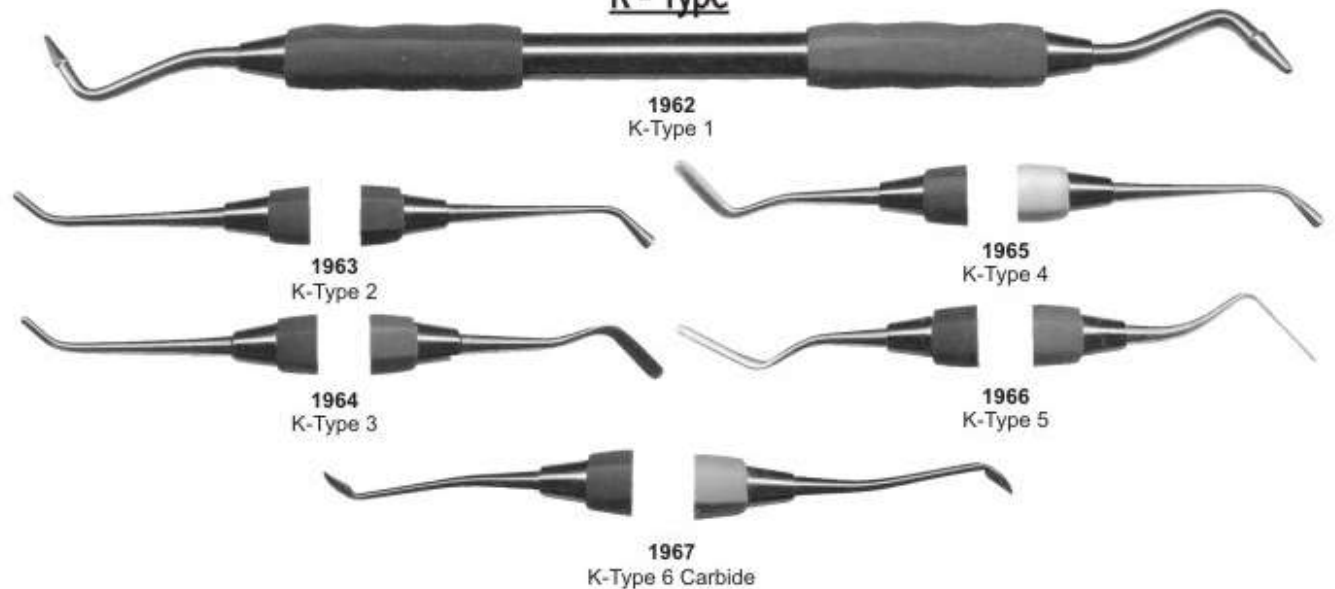





# MOSSIDENT

Dental Surgical Instruments Supplier

Surgery Instruments  
instrumentos de cirugía  
instruments de chirurgie  
ascensori per radici  
أدوات الجراحة



## PLASTIC FILLING INSTRUMENTS

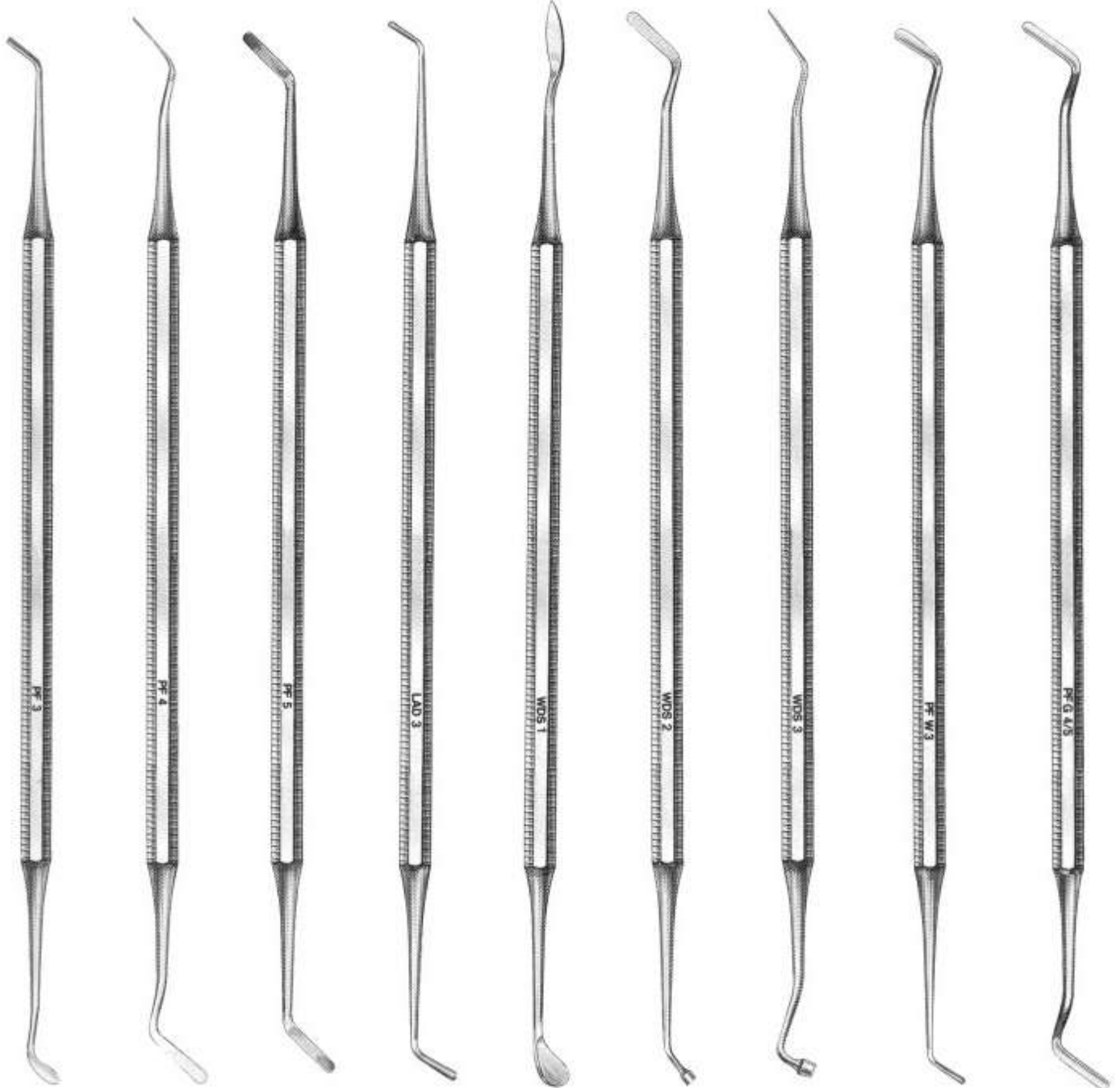

1968  
No.3

1969  
No.4

1970  
No.5

1971  
LADMORE  
Fig. 3

1972  
WOODSON  
Fig. 1

1973  
WOODSON  
Fig. 2

1974  
WOODSON  
Fig. 3

1975  
W-3

1976  
Gregg  
4/5



**MOSSIDENT**

Dental Surgical Instruments Supplier

Surgery Instruments  
instrumentos de cirugia  
instruments de chirurgie  
ascensori per radici  
أدوات الجراحة



**PLASTIC FILLING INSTRUMENTS**



**1977**  
Fig. 5-7



**1978**  
Fig.1



**1979**  
Fig. 3



**1983**  
GLICK  
Fig.1



**1980**  
Fig. 4



**1984**  
P8



**1981**  
Fig. 5-7



**1985**  
WOODSON  
Fig. 1



**1982**  
Fig. 8A



**1986**  
WOODSON  
Fig. 2



**1987**  
WOODSON  
Fig. 3





**MOSSIDENT**

Dental Surgical Instruments Supplier

Surgery Instruments  
instrumentos de cirugia  
instruments de chirurgie  
ascensori per radici  
أدوات الجراحة



## GRACEY CURETTES



**1988**  
GRACEY  
GC 1-2



**1989**  
GRACEY  
GC 3-4



**1990**  
GRACEY  
GC 5-6



**1991**  
GRACEY  
GC 7-8



**1992**  
GRACEY  
GC 9-10



**1993**  
GRACEY  
GC 11-12



**1994**  
GRACEY  
GC 13-14



# MOSSIDENT

Dental Surgical Instruments Supplier

Surgery Instruments  
instrumentos de cirugia  
instruments de chirurgie  
ascensori per radici  
أدوات الجراحة



## GRACEY CURETTES



1995  
G1-2



1996  
G3-4



1997  
G5-6



1998  
G7-8



1999  
G9-10



2000  
G11-12



2001  
G13-14





# MOSSIDENT

Dental Surgical Instruments Supplier

Surgery Instruments  
instrumentos de cirugia  
instruments de chirurgie  
ascensori per radici  
أدوات الجراحة



## CURETTES 4 HANDLES

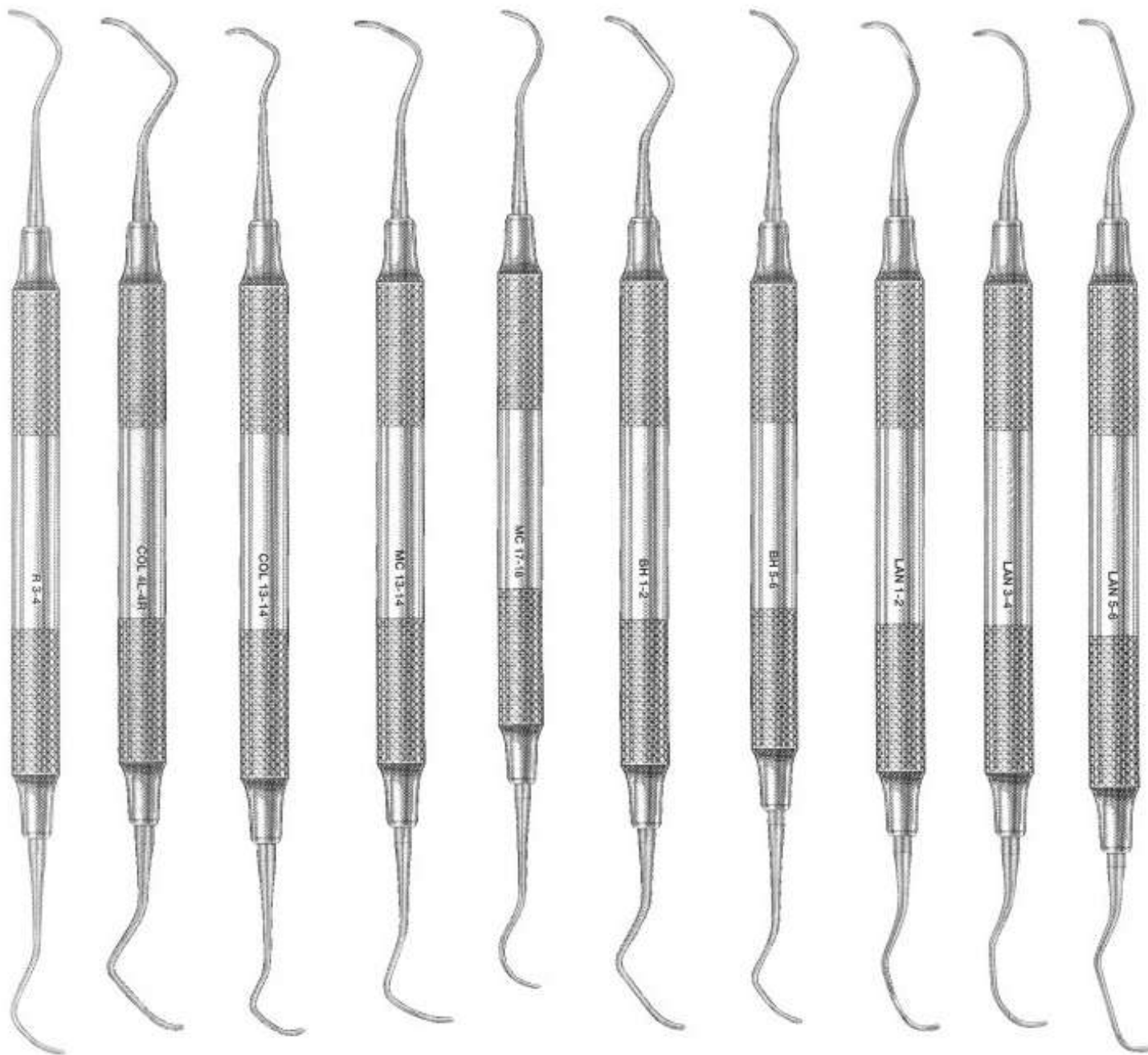

<b>2002</b> RULE 3-4	<b>2003</b> COLUMBIA 4R-4L	<b>2004</b> COLUMBIA 13-14	<b>2005</b> MCCALLS 13-14	<b>2006</b> MCCALLS 17-18	<b>2007</b> BARNHART 1-2	<b>2008</b> BARNHART 5-6	<b>2009</b> LANGER 1-2	<b>2010</b> LANGER 3-4	<b>2011</b> LANGER 5-6
----------------------------	----------------------------------	----------------------------------	---------------------------------	---------------------------------	--------------------------------	--------------------------------	------------------------------	------------------------------	------------------------------



**MOSSIDENT**

Dental Surgical Instruments Supplier

Surgery Instruments  
instrumentos de cirugia  
instruments de chirurgie  
ascensori per radici  
أدوات الجراحة



## CURETTES

### COLUMBIA CURETTES



2012  
4L-4R

2013  
13-14

2014  
2L-2R

### MCCALLS CURETTES



2015  
13-14

2016  
13S-14S

2017  
17-18

2018  
17S-18S



**MOSSIDENT**

Dental Surgical Instruments Supplier

Surgery Instruments  
instrumentos de cirugia  
instruments de chirurgie  
ascensori per radici  
أدوات الجراحة



## CURETTES

### GOLDMAN FOX



**2019**  
GF1 Universal Scaler



**2020**  
GF2 Curette



**2021**  
GF3 Curette



**2022**  
GF4 Curette



**2023**  
GF5 Hoe



**2024**  
GF6 Hoe



**MOSSIDENT**

Dental Surgical Instruments Supplier

Surgery Instruments  
instrumentos de cirugia  
instruments de chirurgie  
ascensori per radici  
أدوات الجراحة



## CURETTES

### GOLDMAN FOX



**2025**  
GF 7 Knife



**2026**  
GF 8 Spear Knife



**2027**  
GF 9 Knife Scaler



**2028**  
GF 11 Spear Knife



**2029**  
GF 21 Sharp Spoon /  
Small Scaler





**MOSSIDENT**  
Dental Surgical Instruments Supplier

Surgery Instruments  
instrumentos de cirugía  
instruments de chirurgie  
ascensori per radici  
أدوات الجراحة



## KNIVES/ INTERPROXIMAL FILES



**2030**  
Kirkland 15 / 16



**2031**  
Ordan 1 / 2



**2032**  
Buck 3 / 4

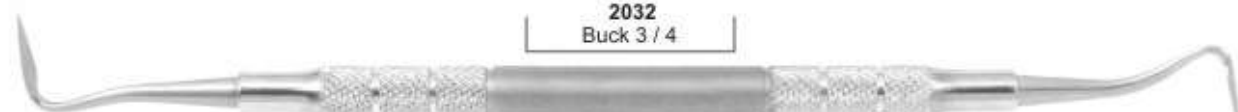

**2033**  
Buck 5 / 6



**2034**  
Goldman-Fox 7



**2035**  
Goldman-Fox 8



**2036**  
Goldman-Fox 9



**2037**  
Goldman-Fox 11



**2038**  
CK 3 (Crane)

### Interproximal Files



**2039**  
Sugarman 1S-2S



**2040**  
Sugarman 3S-4S



**2041**  
Schluger 9 - 10



**2042**  
Buck 11 - 12



**CURETTES/ ROOT PLANING CURETTES**



**2043**  
COLUMBIA (2L-2R)



**2044**  
MCCALL (13-14)



**2045**  
MCCALL (17S-18S)

**Root Planning Cures**



**2046**  
Root Plane (1-2)



**2047**  
Root Plane (5-6)



**2049**  
Root Plane (11-12)



**2048**  
Root Plane (7-8)



**2050**  
Root Plane (13-14)



**2051**  
Petite (1-2)



**2052**  
Petite (11-12)



**2053**  
Petite (5-6)



**2054**  
Petite (13-14)



## CURTTES



**2055**  
BARNHART (1-2)



**2056**  
BARNHART (5-6)



**2065**  
COLUMBIA (4L-4R)

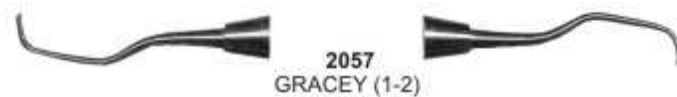

**2057**  
GRACEY (1-2)



**2066**  
COLUMBIA (13-14)

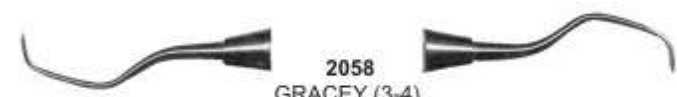

**2058**  
GRACEY (3-4)



**2067**  
LANGER (1-2)

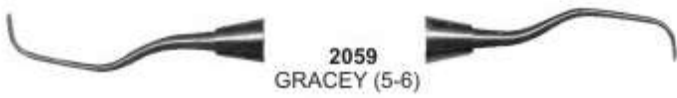

**2059**  
GRACEY (5-6)



**2068**  
LANGER (3-4)

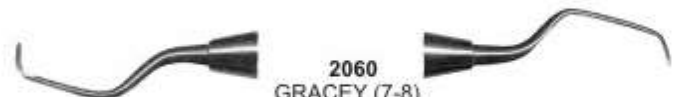

**2060**  
GRACEY (7-8)



**2069**  
LANGER (5-6)



**2061**  
GRACEY (9-10)



**2070**  
MCCALL (13-14)



**2062**  
GRACEY (11-12)



**2071**  
MCCALL (13S-14S)



**2063**  
GRACEY (13-14)



**2072**  
MCCALL (17-18)

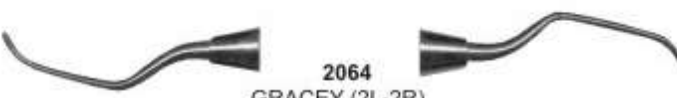

**2064**  
GRACEY (2L-2R)



**2073**  
MCCALL (17S-18S)



**2074**  
RULE (3-4)



**MOSSIDENT**

Dental Surgical Instruments Supplier

Surgery Instruments  
instrumentos de cirugia  
instruments de chirurgie  
ascensori per radici  
أدوات الجراحة



## SILICON HANDLE INSTRUMENTS

### Silicon Handles-Reusable

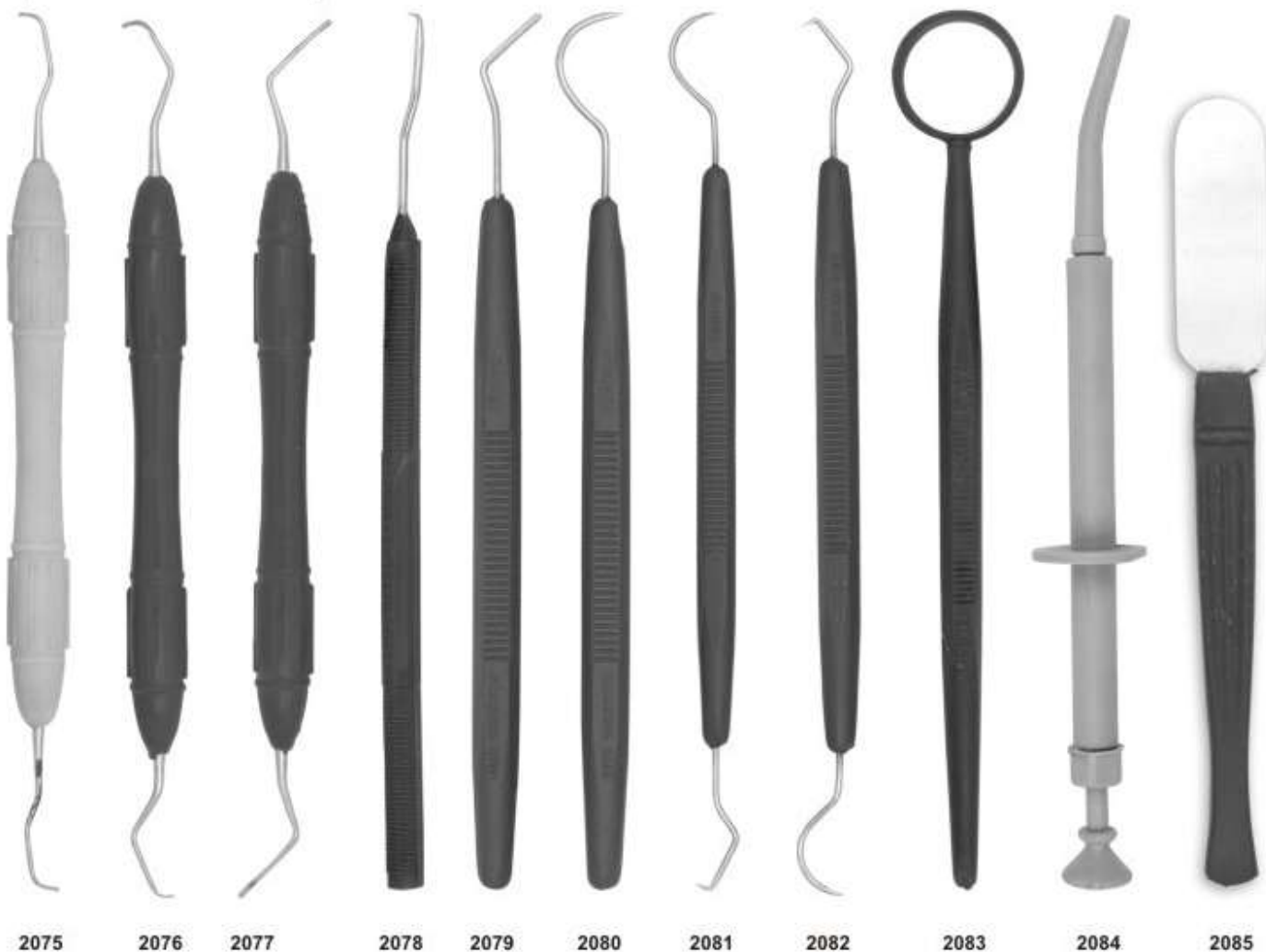





# MOSSIDENT

Dental Surgical Instruments Supplier

Surgery Instruments  
instrumentos de cirugia  
instruments de chirurgie  
ascensori per radici  
أدوات الجراحة



## CEMENT INSTRUMENTS

### Comfort Grip Vinyl - Covered Insulating Handles



2091  
ROACH-A

2092  
ROACH-B

2093  
LECRON 5-A

2094  
LECRON 5-B

2095  
VEHE-A

2096  
VEHE-B

2097  
A7

2098  
B7

2099  
WARD 2-A

2100  
WARD 2-B



# MOSSIDENT

Dental Surgical Instruments Supplier

Surgery Instruments  
instrumentos de cirugia  
instruments de chirurgie  
ascensori per radici  
أدوات الجراحة



## CEMENT INSTRUMENTS

### P.K. THOMAS

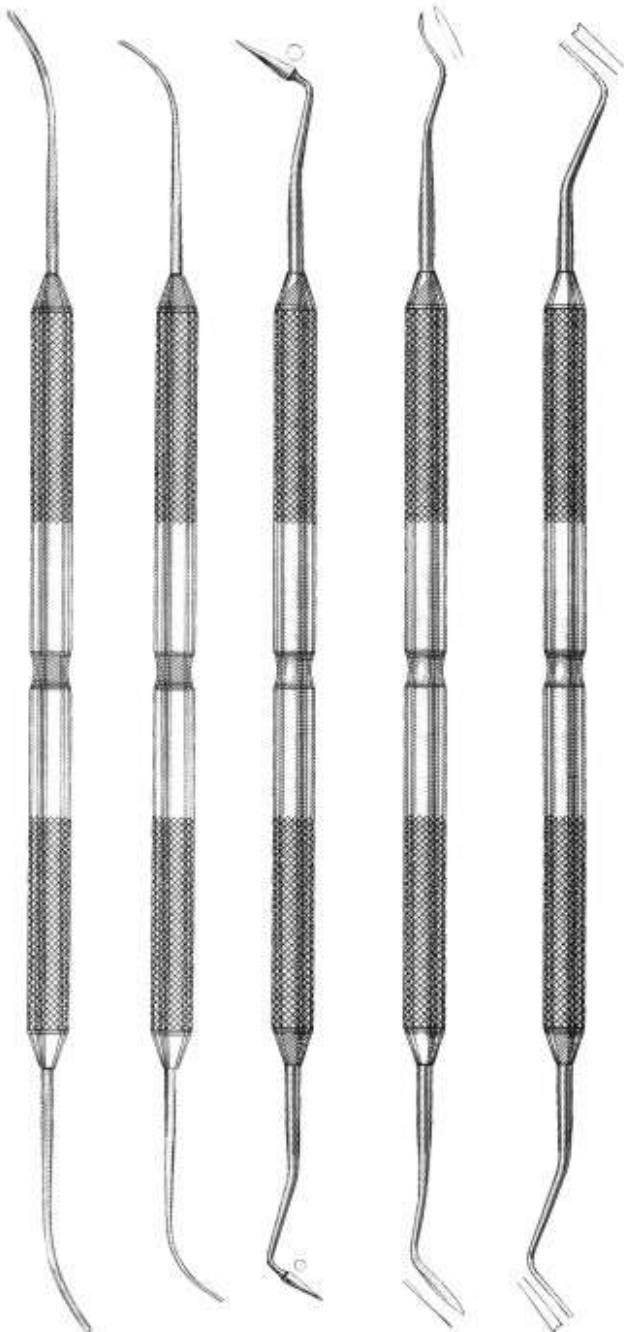

2101  
PKT 1

2102  
PKT 2

2103  
PKT 3

2104  
PKT 4

2105  
PKT 5

Set of 5 instruments

### WAX CARVERS

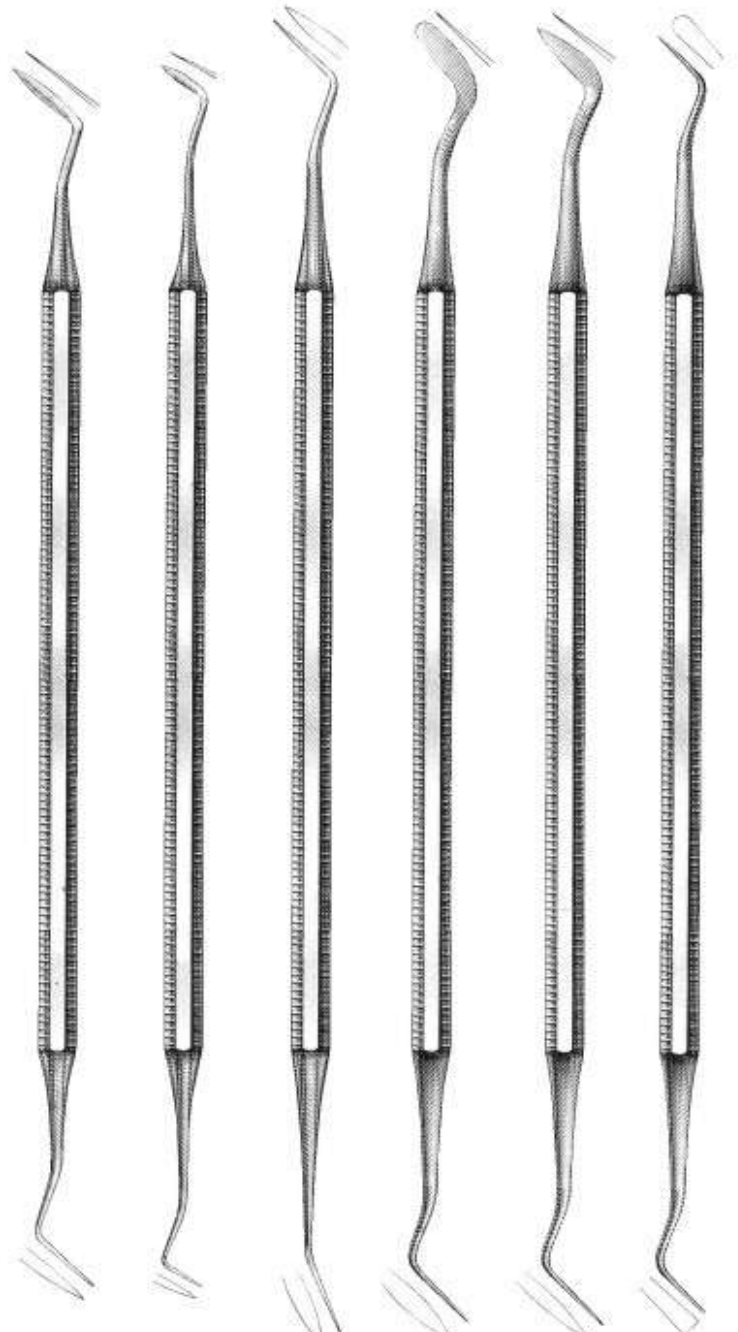

2106  
Hollenback 3

2107  
Hollenback 3S

2108  
WARD 1

2109  
WARD 2

2110  
WALL 1

2111  
WALL 3



# MOSSIDENT

Dental Surgical Instruments Supplier

Surgery Instruments  
instrumentos de cirugía  
instruments de chirurgie  
ascensori per radici  
أدوات الجراحة



## CEMENT SPATULLAS

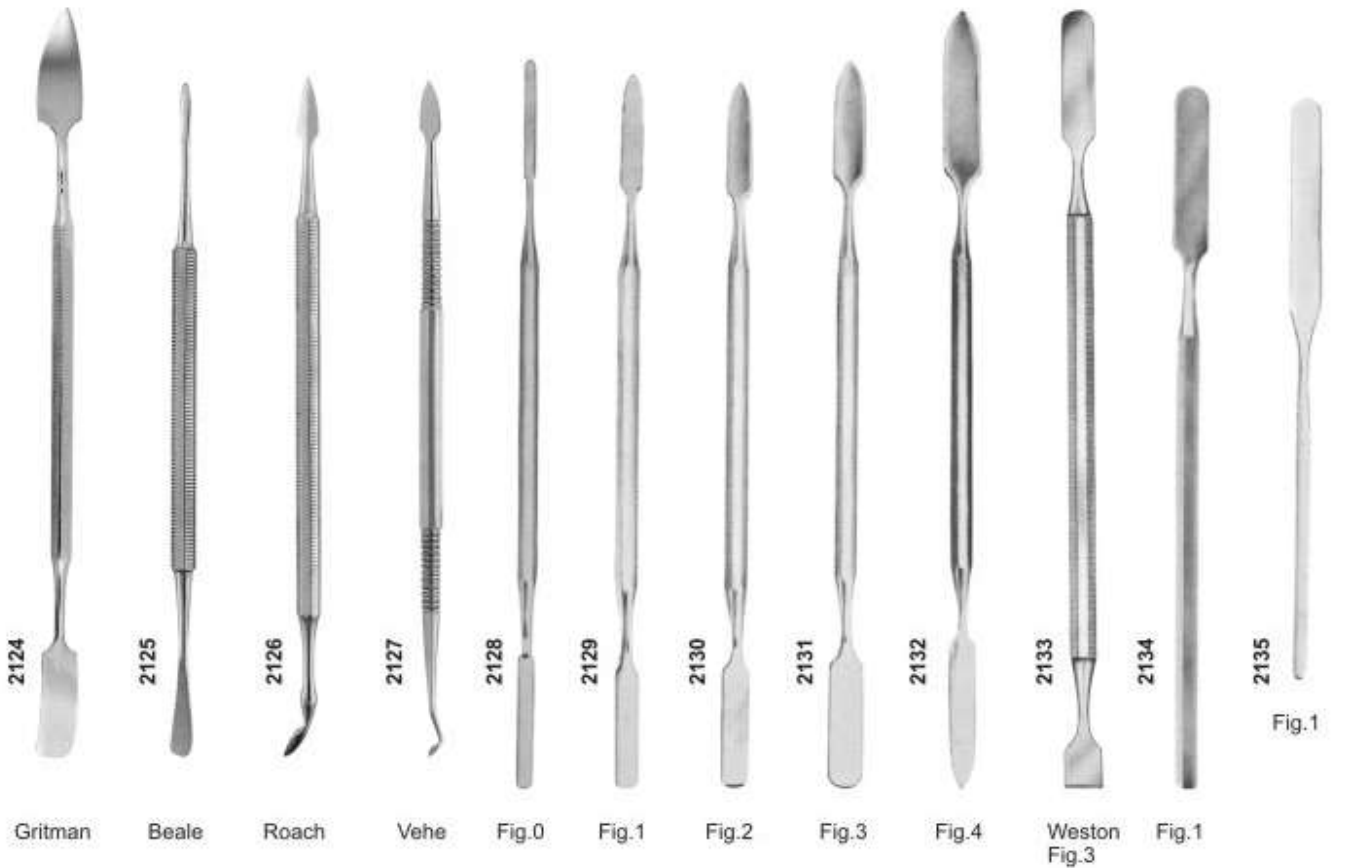
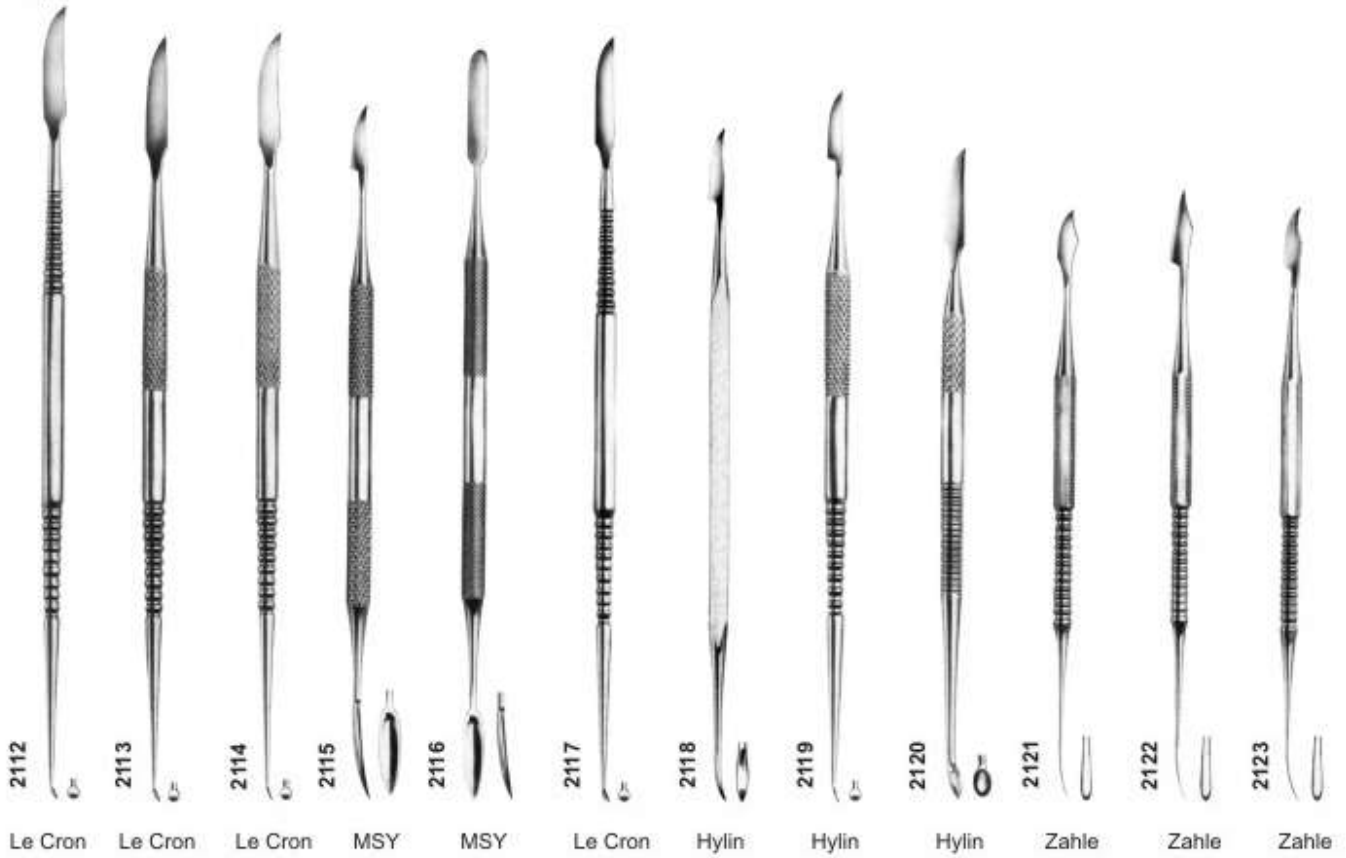





**MOSSIDENT**

Dental Surgical Instruments Supplier

Surgery Instruments  
instrumentos de cirugia  
instruments de chirurgie  
ascensori per radici  
أدوات الجراحة



**CEMENT INSTRUMENTS**

**WAX & PORCELAINE CARVERS**

**WAX SPATULAS**



2136  
LECRON  
Inlay



2137  
REEVES



2138  
VEHE  
Wax



2139  
ROACH  
Wax



2140  
W-31



2141  
W-5



2142  
W-7



2143  
W-7A

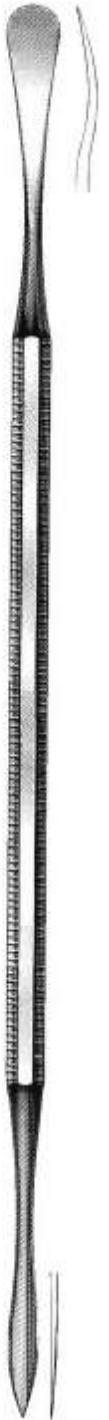

2144  
W-7G





**MOSSIDENT**  
Dental Surgical Instruments Supplier

Surgery Instruments  
instrumentos de cirugia  
instruments de chirurgie  
ascensori per radici  
أدوات الجراحة



## CEMENT SPATULAS



**2145**  
AGATHE



**2146**  
C-7



**2147**  
C-5

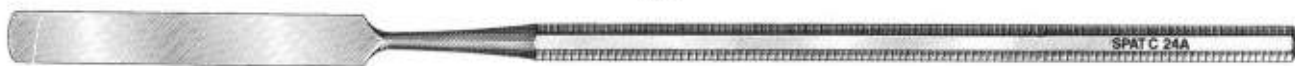

**2148**  
C-313



**2149**  
C-24A Rigid



**2150**  
C-24 Flexible



**2151**  
C-24 Flexible



**2152**  
24



**2153**  
A6



**2154**  
7 Wax



**2155**  
26



**2156**  
All Metal Spatulas with High Polish  
Stainless Steel Blade



**2157**  
31



**MOSSIDENT**

Dental Surgical Instruments Supplier

Surgery Instruments  
instrumentos de cirugía  
instruments de chirurgie  
ascensori per radici  
أدوات الجراحة



## SPATULAS

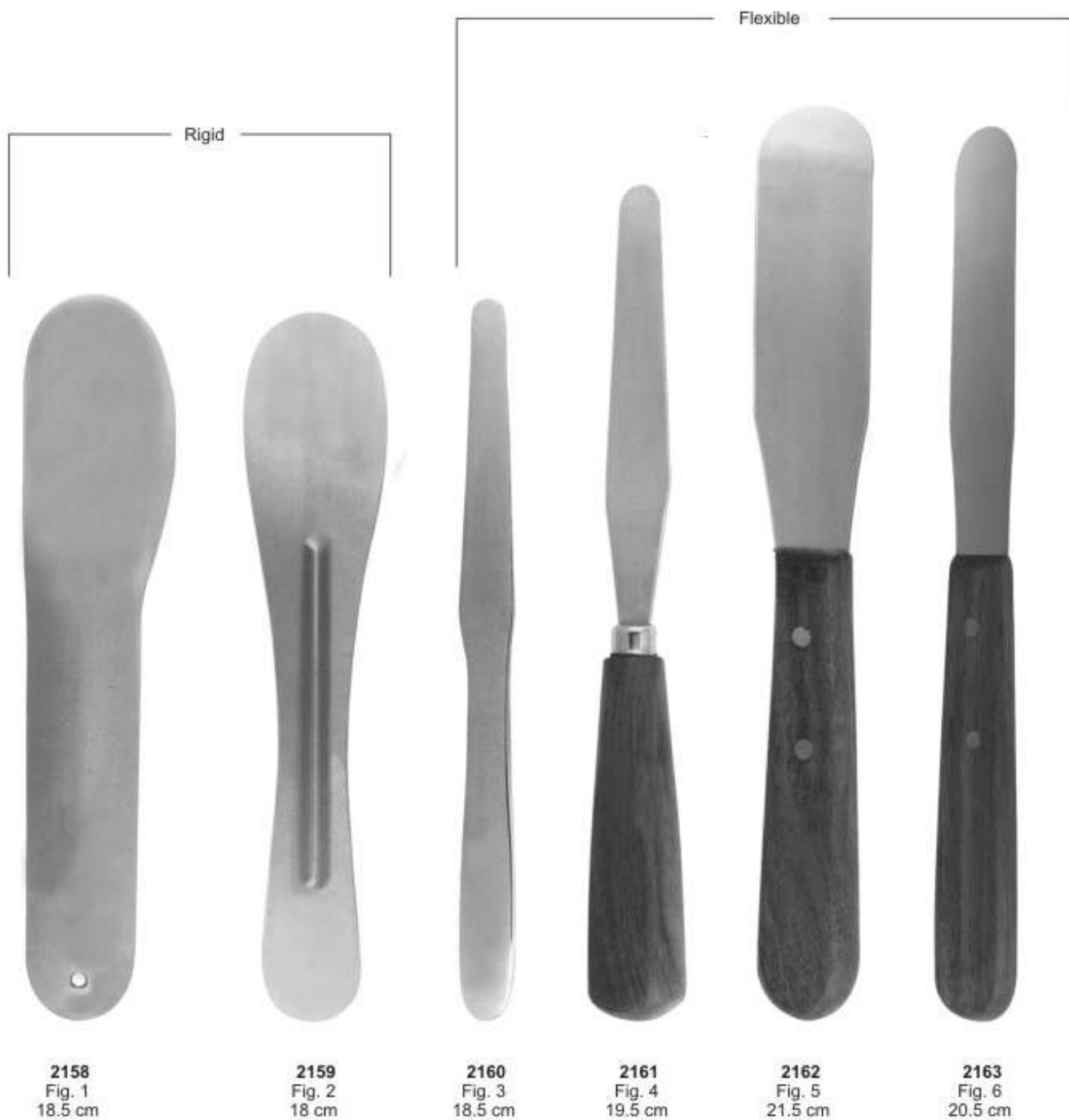



**MOSSIDENT**

Dental Surgical Instruments Supplier

Surgery Instruments  
instrumentos de cirugía  
instruments de chirurgie  
ascensori per radici  
أدوات الجراحة



## SPATULAS

Flexible



2164  
Fig. 7  
19.5 cm

Rigid



2165  
Fig. 8  
20 cm

2166  
Fig. 9  
22.5 cm



**FILES/ HOES/ KNIVES**

**FILES**



**HOES**

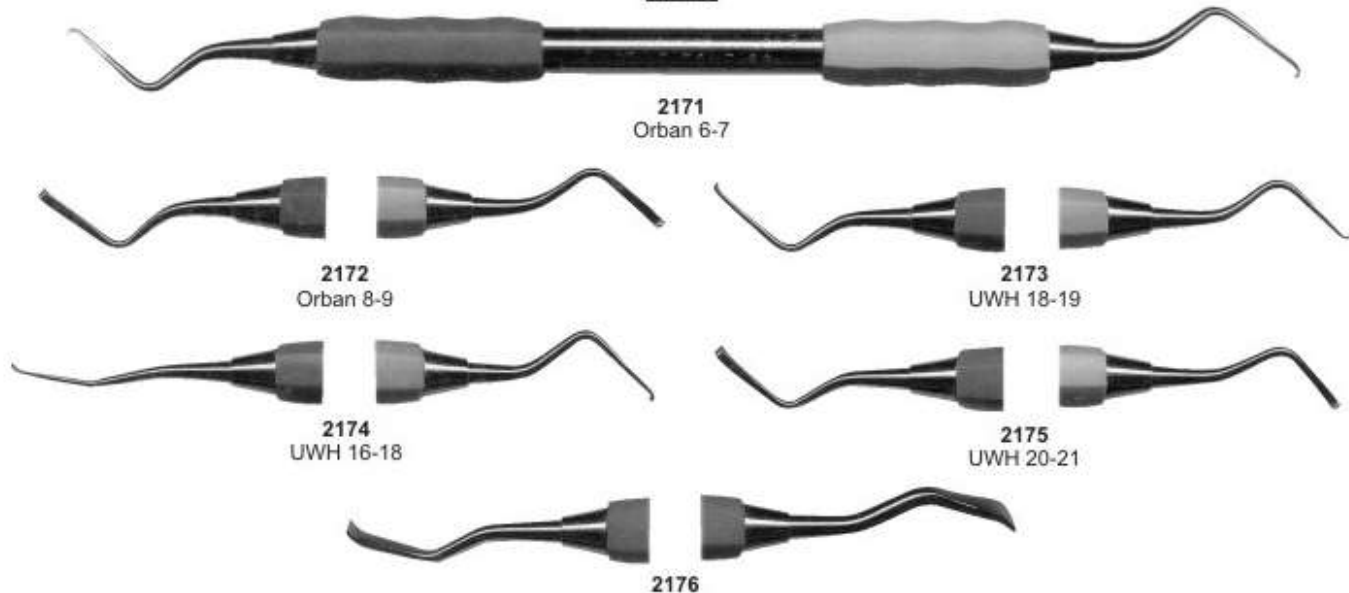

**KNIVES**

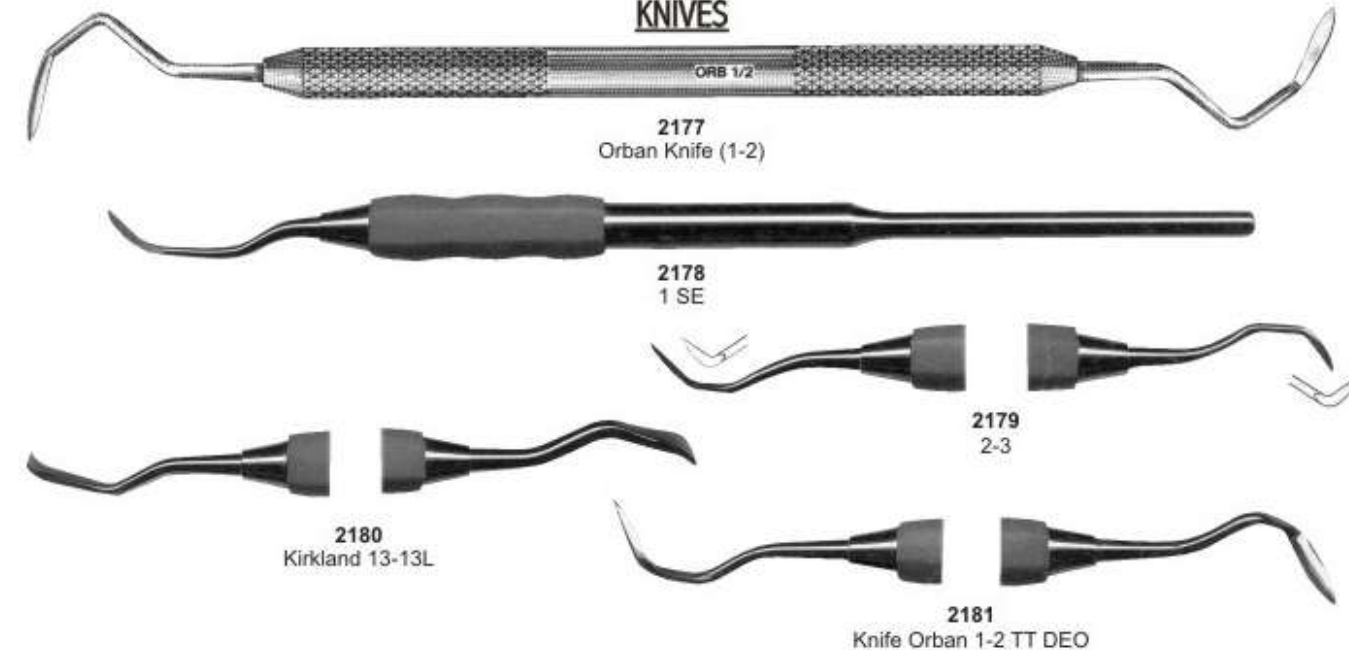





**MOSSIDENT**

Dental Surgical Instruments Supplier

Surgery Instruments  
instrumentos de cirugía  
instruments de chirurgie  
ascensori per radici  
أدوات الجراحة



## WAX KNIVES



**2182**  
Fahnenstock  
Fig. 1  
12,5cm



**2183**  
Fahnenstock  
Fig. 2  
17cm



**2184**  
Lessmann  
Fig. 1  
12,5cm



**2185**  
Lessmann  
Fig. 2  
17cm



**2186**  
Con scodellino  
Fig. 1  
12,5cm



**2187**  
Con scodellino  
Fig. 2  
17cm



**2188**  
Ermert



**2189**  
Ermert



# MOSSIDENT

Dental Surgical Instruments Supplier

Surgery Instruments  
instrumentos de cirugia  
instruments de chirurgie  
ascensori per radici  
أدوات الجراحة



## WAX KNIVES / PLASTER KNIVES



**2190**  
18 cm  
7 1/8"



**2191**  
18 cm  
7 1/8"



**2192**  
17 cm  
6 3/4"  
Gritman



**2193**  
17 cm  
6 3/4"  
Medicon



**2194**  
Fig. 1  
17 cm



**2195**  
22 cm  
8 3/4"



**2196**  
22 cm  
8 3/4"



**2197**  
Gritman  
Fig. 2  
17 cm



**2198**  
Fig. 3  
16 cm



**2199**  
Fig. 4  
16 cm



**MOSSIDENT**  
Dental Surgical Instruments Supplier

Surgery Instruments  
instrumentos de cirugia  
instruments de chirurgie  
ascensori per radici  
أدوات الجراحة



**CRANE-KAPLAN/ CHIESEL**

**CRANE-KAPLAN**



**2200**  
Ck1  
Pocket Marker



**2201**  
Ck2  
Pocket Marker



**2202**  
Knife



**2203**  
Dissector



**2204**  
Scaler

**OCHSENBEIN**



**2205**  
Ochsenbein  
Fig. 1



**2206**  
Ochsenbein  
Fig. 2



**2207**  
Ochsenbein  
Fig. 4

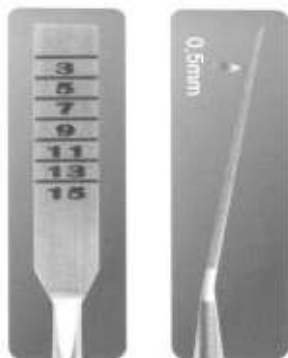

Split Chisel Set



**2208**  
Split Chisel  
6 mm Curved



**2209**  
Split Chisel  
6 mm Straight



**2210**  
Split Chisel  
4 mm Curved



**2211**  
Split Chisel  
4 mm Straight



# MOSSIDENT

Dental Surgical Instruments Supplier

Surgery Instruments  
instrumentos de cirugia  
instruments de chirurgie  
ascensori per radici  
أدوات الجراحة



## BONE CURTTES

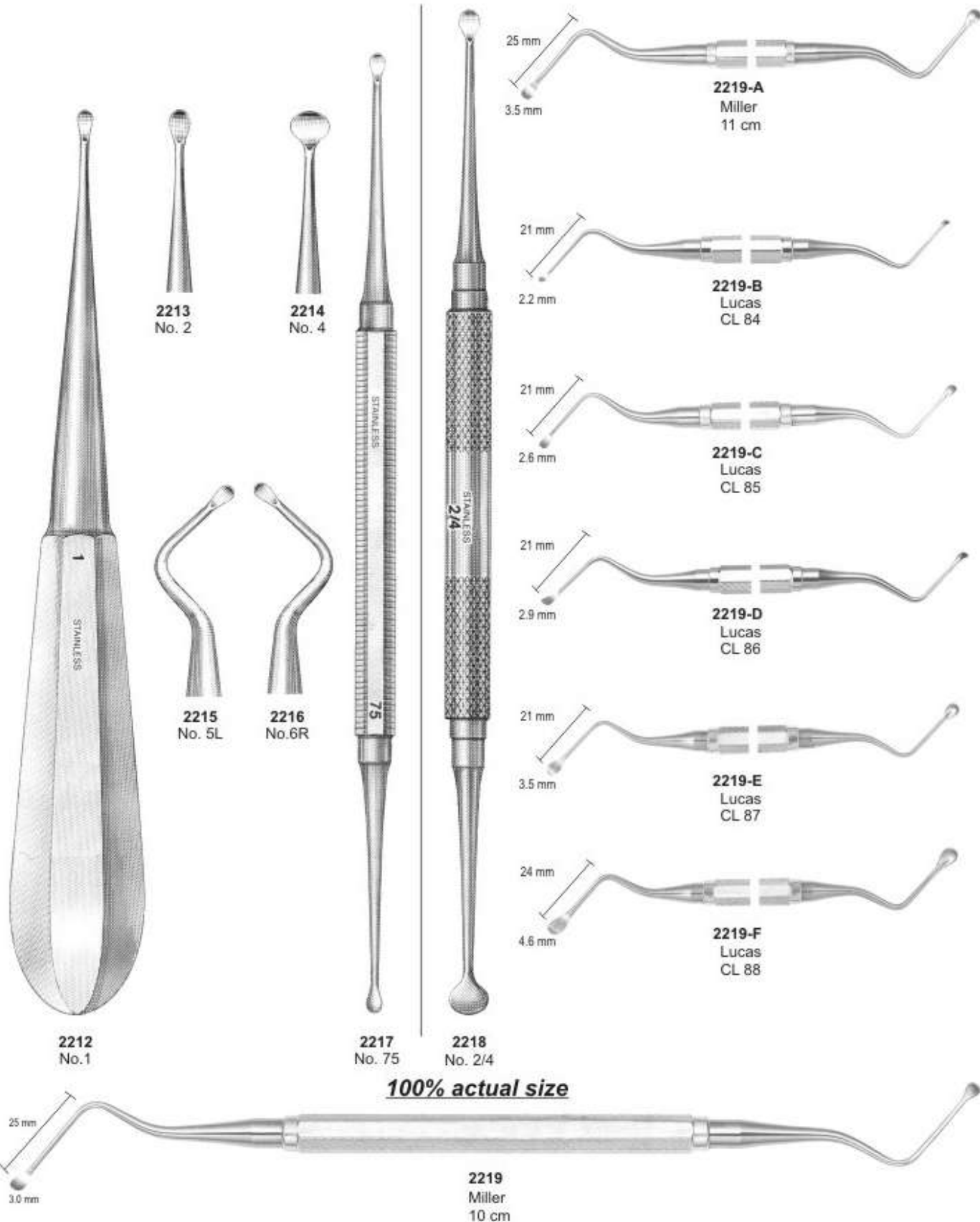





**MOSSIDENT**

Dental Surgical Instruments Supplier

Surgery Instruments  
instrumentos de cirugia  
instruments de chirurgie  
ascensori per radici  
أدوات الجراحة



## BONE FILES

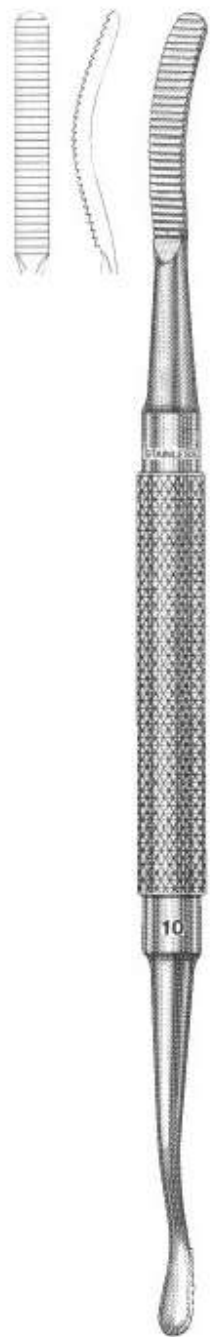

**2220**  
No. 10



**2221**  
No. 33

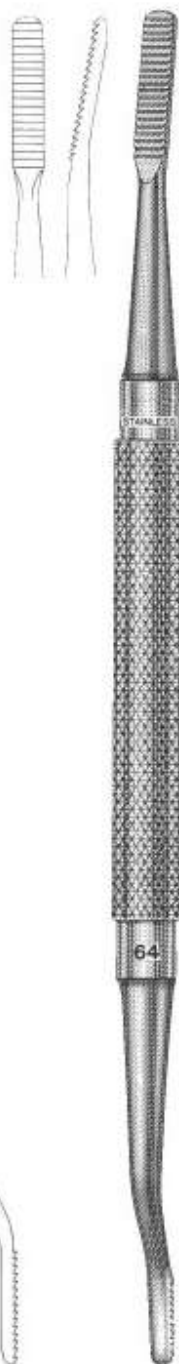

**2222**  
MILLER  
No. 64

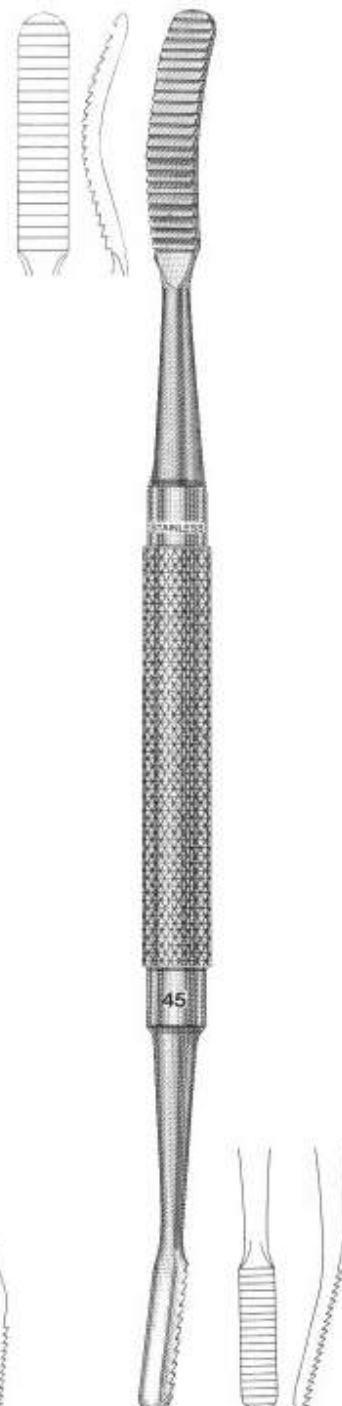

**2223**  
MILLER  
No. 64



**MOSSIDENT**

Dental Surgical Instruments Supplier

Surgery Instruments  
instrumentos de cirugia  
instruments de chirurgie  
ascensori per radici  
أدوات الجراحة



## BONE FILES

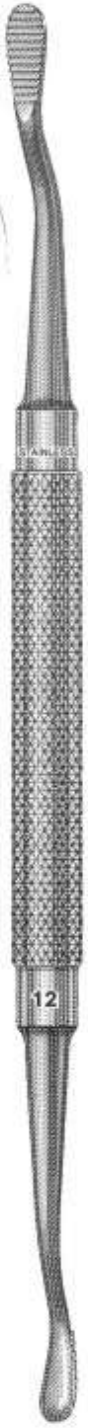
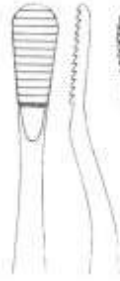

**2224**  
HOWARD  
No. 12

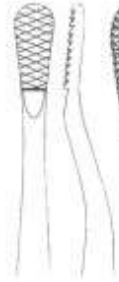

**2225**  
HOWARD  
No. 12A



**2226**  
HOWARD  
No. 12CA

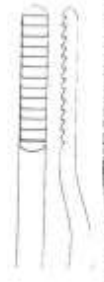

**2227**  
POLOKOFF  
No. 1



# MOSSIDENT

Dental Surgical Instruments Supplier

Surgery Instruments  
instrumentos de cirugia  
instruments de chirurgie  
ascensori per radici  
أدوات الجراحة



## BONE CHISELS

### GARDNER

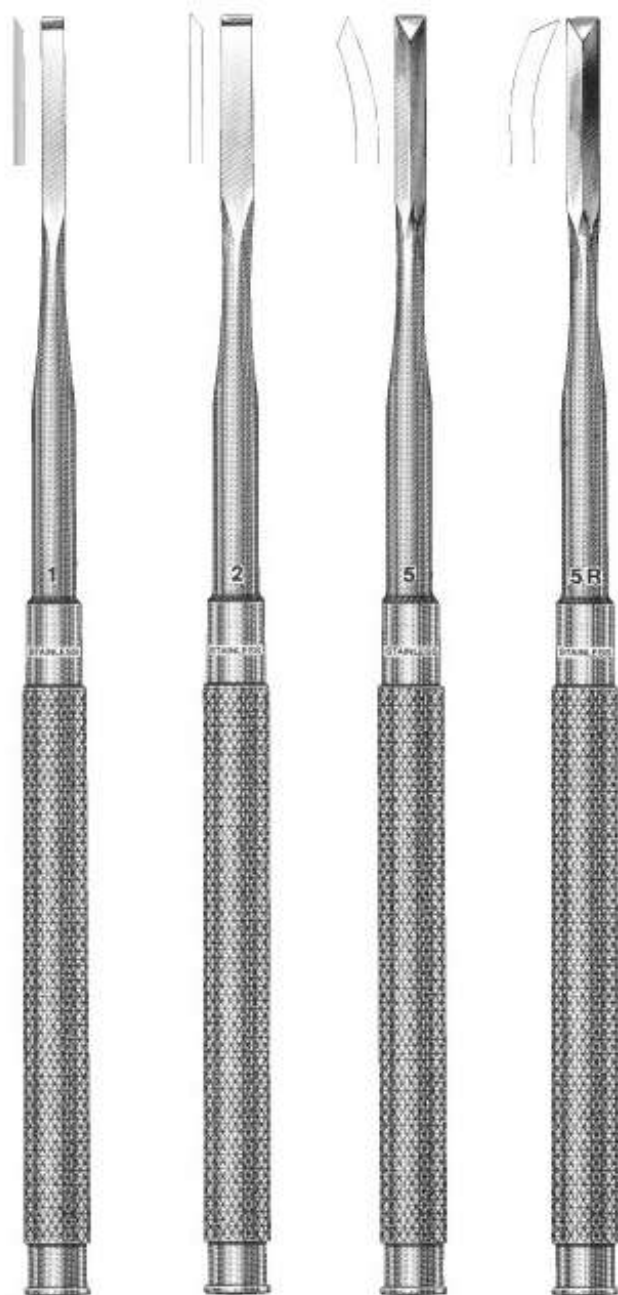

**2228**  
GARDNER  
No. 1

**2229**  
GARDNER  
No. 2

**2230**  
GARDNER  
No. 5

**2231**  
GARDNER  
No. 5R

### WAKEFIELD



**2232**  
WAKEFIELD  
No. 1W

**2233**  
WAKEFIELD  
No. 2W



**BONE CHISEL/ BONE MALLETS**

**Bone Chisels and Gouges**

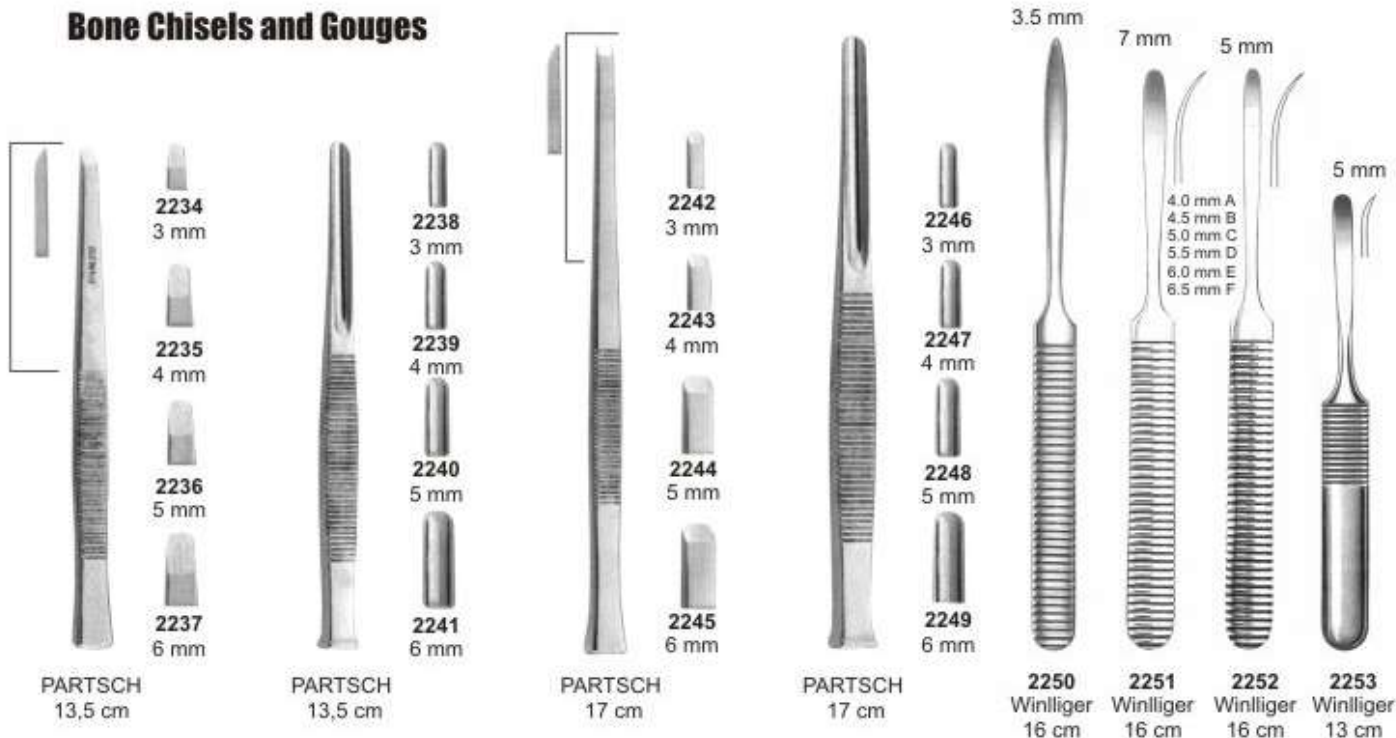

Martelli chirurgici  
Mallet







# MOSSIDENT

Dental Surgical Instruments Supplier

Surgery Instruments  
instrumentos de cirugia  
instruments de chirurgie  
ascensori per radici  
أدوات الجراحة



## CROWN REMOVERS

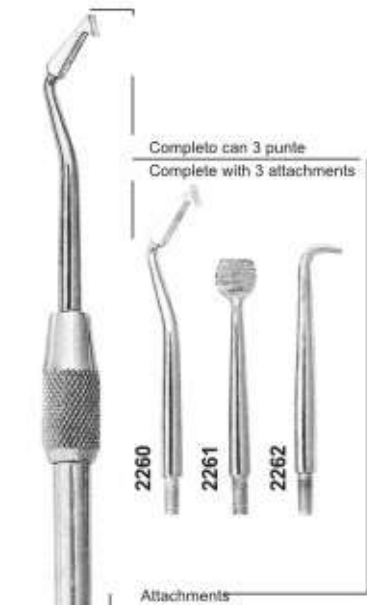

Completo con 3 punte  
Complete with 3 attachments

2260

2261

2262

Attachments



2265  
Traymann,  
Crown Remover  
17.0 cm



2266

Attachments

2268



2259



2263  
Crown Spreader, Crown Remove.  
Special instrument for crown spreading  
after separating, simple and safe  
operation.



2264  
Traymann,  
Crown Remover  
17.0 cm



2266



2267



# MOSSIDENT

Dental Surgical Instruments Supplier

Surgery Instruments  
instrumentos de cirugia  
instruments de chirurgie  
ascensori per radici  
أدوات الجراحة



## CROWN INSTRUMENTS





# MOSSIDENT

Dental Surgical Instruments Supplier

Surgery Instruments  
instrumentos de cirugia  
instruments de chirurgie  
ascensori per radici  
أدوات الجراحة



## CROWN INSTRUMENTS



**2282**  
Plaster Shear  
210 mm



**2283**  
Crown Removing Plier  
14 cm



**2284**  
MONTFORT  
18 CM



**2285**  
BOHM  
16 cm



**2286**  
Telescope Crown  
Plier, Diamond coated  
13.0 cm



**2287**  
Telescope Crown  
Plier, Diamond coated  
13.0 cm



**2288**  
Telescope Crown Plier  
13.0 cm gerieften Maul  
15.0 cm gerieften Maul  
13.0 cm gelatts Maul  
15.0 cm gelatts Maul



**2289**  
Telescope Crown  
Plier, Fine  
15.0 cm



# MOSSIDENT

Dental Surgical Instruments Supplier

Surgery Instruments  
instrumentos de cirugia  
instruments de chirurgie  
ascensori per radici  
أدوات الجراحة



## IMPLANT INSTRUMENTS

 <b>2290</b> 1P 150 mm	$\varnothing$ 2 mm  1P 150 mm	$\varnothing$ 2.7 mm  2P 150 mm	$\varnothing$ 3.25 mm  3P 150 mm	$\varnothing$ 3.8 mm  4P 150 mm
	$\varnothing$ 3 mm  1T 150 mm	$\varnothing$ 4 mm  2T 150 mm	$\varnothing$ 5 mm  3T 150 mm	
	$\varnothing$ 1.60 mm  1 155 mm	$\varnothing$ 1.90 mm  2 155 mm	$\varnothing$ 2.80 mm  3 155 mm	
	$\varnothing$ 1.60 mm  4 155 mm	$\varnothing$ 1.90 mm  5 155 mm	$\varnothing$ 2.80 mm  6 155 mm	





# MOSSIDENT

Dental Surgical Instruments Supplier

Surgery Instruments  
instrumentos de cirugia  
instruments de chirurgie  
ascensori per radici  
أدوات الجراحة



## IMPLANT INSTRUMENTS



**2292**  
Fig. 1B  
165 mm

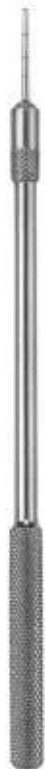
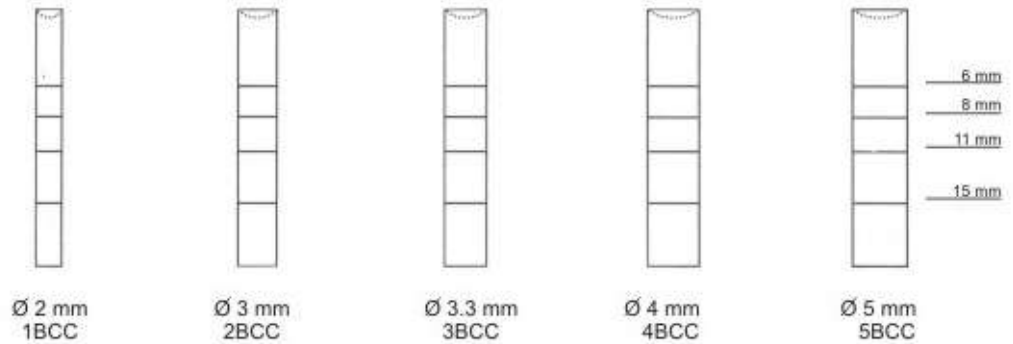
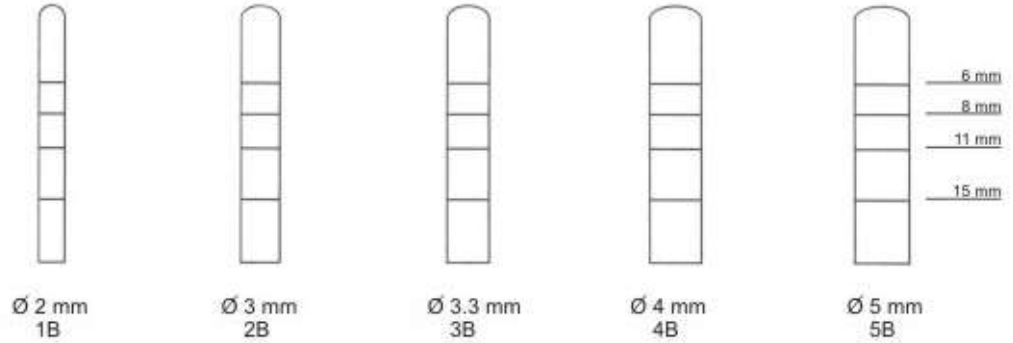

**2293**  
Fig. 1  
155 mm

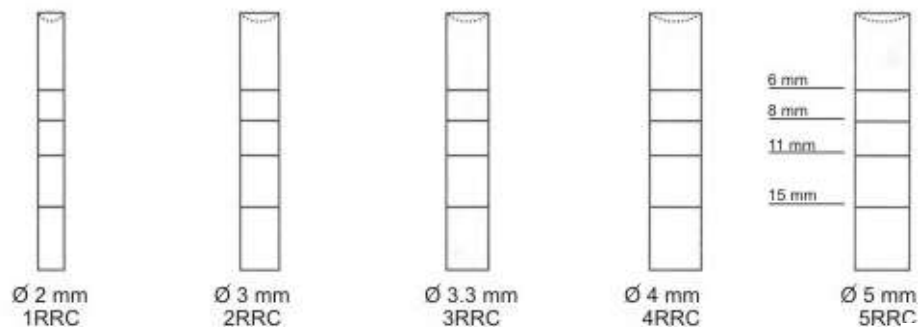
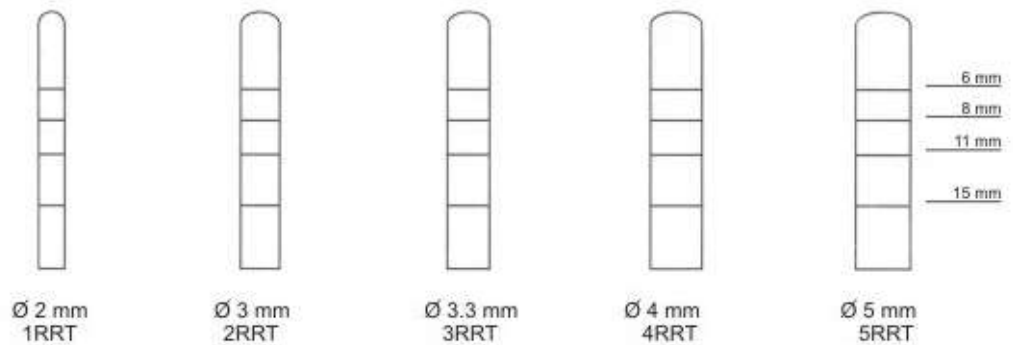



# MOSSIDENT

Dental Surgical Instruments Supplier

Surgery Instruments  
instrumentos de cirugía  
instruments de chirurgie  
ascensori per radici  
أدوات الجراحة



## IMPLANT INSTRUMENTS

### Endo guns for retrograds.

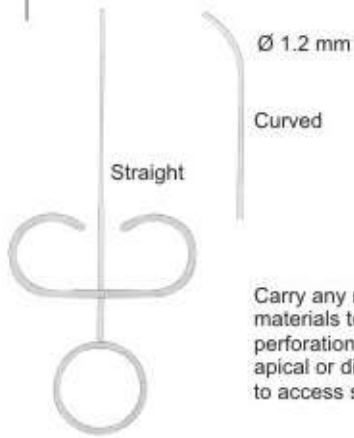

**2294**  
Ø 1.2 mm  
130 mm

Carry any mixed materials to perforations, apical or difficulty to access sites.

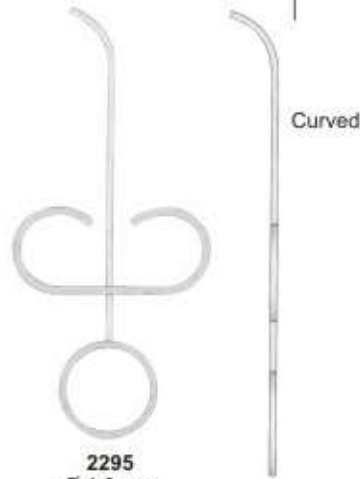

**2295**  
Ø 1.8 mm  
130 mm



### Bone Injectors



**2296**  
Ø 2.5 mm  
150 mm



**2297**  
Ø 4.4 mm  
150 mm



**2298**  
Ø 7 mm  
150 mm



**2299**  
Ø 2.5 mm  
150 mm



**2300**  
Ø 4.4 mm  
150 mm



Bone well

**2301**  
Ø 35 mm  
h 35 mm



**2302**  
Grinders for autogenous



**2303**  
Bone Mill Forcep  
17.0 cm



# MOSSIDENT

Dental Surgical Instruments Supplier

Surgery Instruments  
instrumentos de cirugia  
instruments de chirurgie  
ascensori per radici  
أدوات الجراحة



## SUCTION TUBES/ BONE PLUGGERS/ RONGEURS

### Suction Tubes

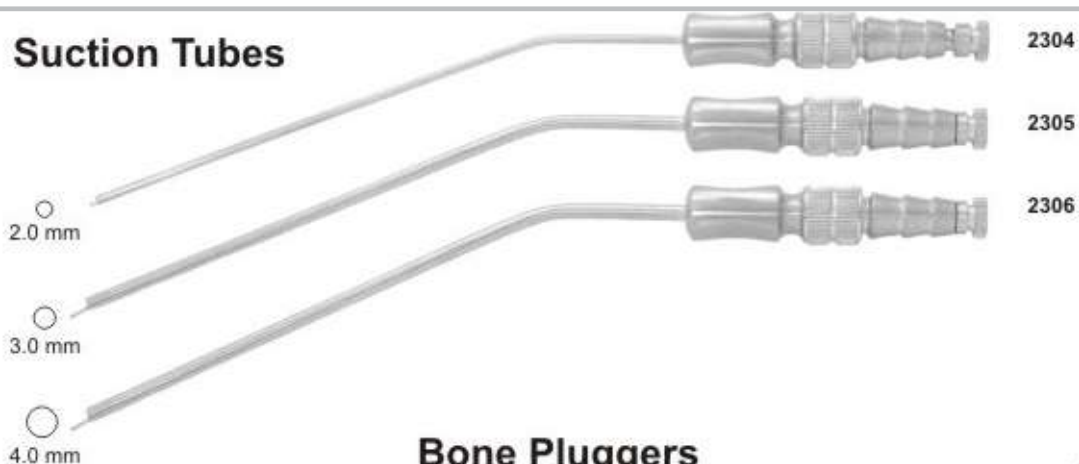

### Bone Pluggers



### Kerrison Rongeurs



( 1.5 mm inside ) 2311  
 ( 2.0 mm inside ) 2312  
 ( 3.0 mm inside ) 2313  
 ( 4.0 mm inside ) 2314  
 ( 4.5 mm inside ) 2315  
 16.5 cm

( 1.0 mm inside ) 2316  
 ( 2.0 mm inside ) 2317  
 ( 2.50 mm inside ) 2318  
 16.5 cm



# MOSSIDENT

Dental Surgical Instruments Supplier

Surgery Instruments  
instrumentos de cirugia  
instruments de chirurgie  
ascensori per radici  
أدوات الجراحة



## IMPLANT INSTRUMENTS



**2319**  
Fig. 1  
170 mm



**2320**  
Fig. 2  
175 mm

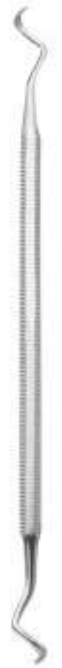

**2321**  
Fig. 3  
170 mm



**2322**  
LUCAS  
Fig. 88  
170 mm

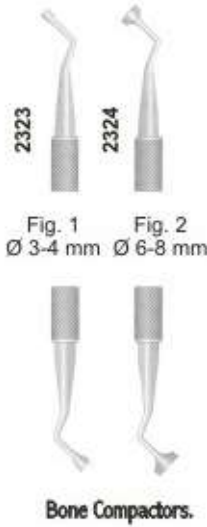

**Bone Compactors.**

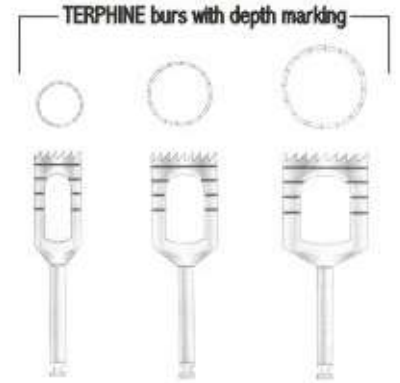

**2325** Ext. Ø 3.5 mm Int. Ø 3 mm  
**2326** Ext. Ø 6 mm Int. Ø 5 mm  
**2327** Ext. Ø 8.5 mm Int. Ø 7.55 mm  
**2328** Ext. Ø 11 mm Int. Ø 10 mm

### Sinus lift instruments



**2329**  
Fig.1



**2330**  
Fig.2



**2331**  
Fig.3



**2332**  
Fig.4



**2333**  
Fig.5



**2334**  
Fig.6



**2335**  
Fig.7



**2336**  
Fig.8



**2337**  
Fig.9





# MOSSIDENT

Dental Surgical Instruments Supplier

Surgery Instruments  
instrumentos de cirugia  
instruments de chirurgie  
ascensori per radici  
أدوات الجراحة



## SUCTION TUBES

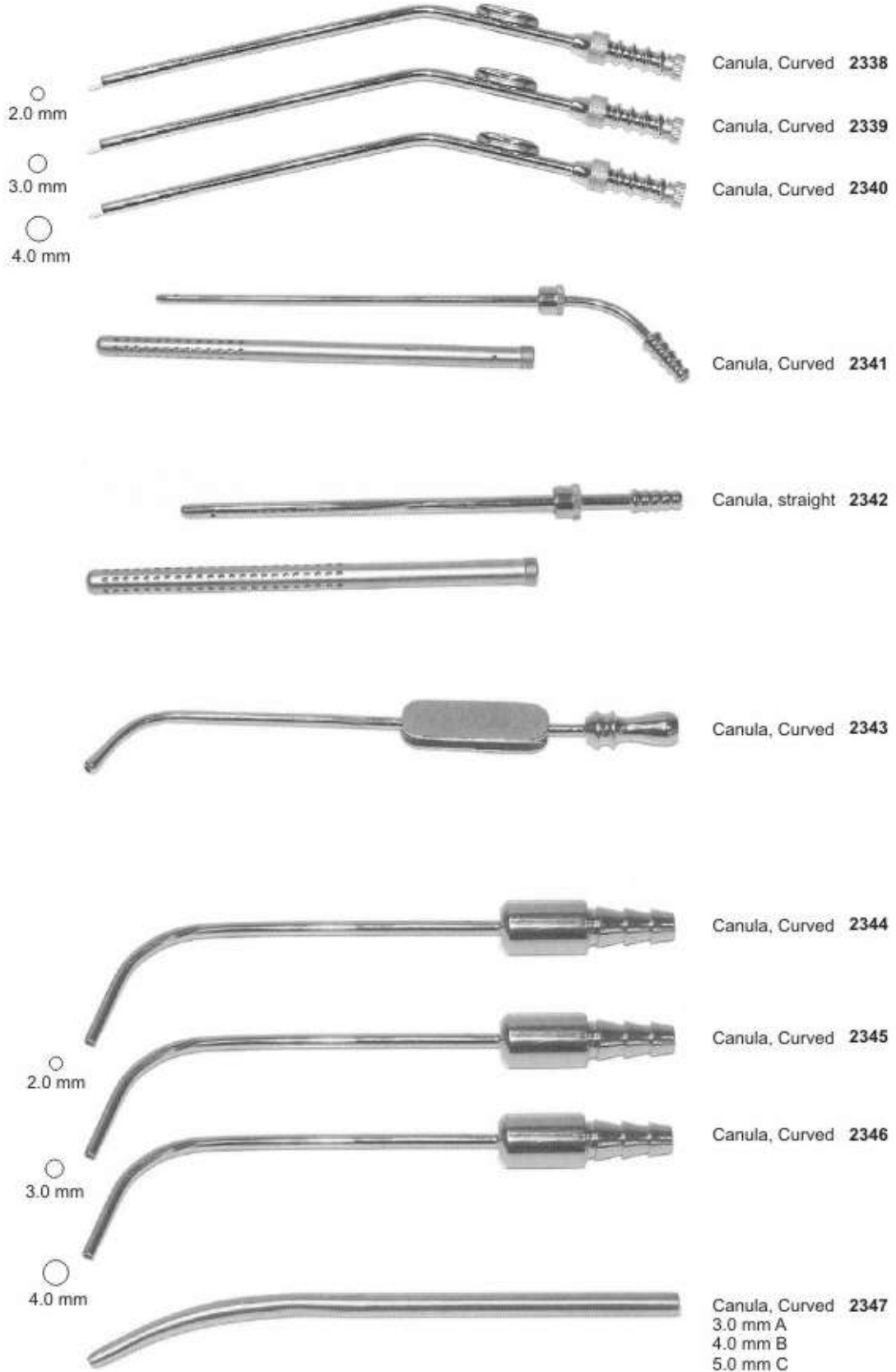



# MOSSIDENT

Dental Surgical Instruments Supplier

Surgery Instruments  
instrumentos de cirugia  
instruments de chirurgie  
ascensori per radici  
أدوات الجراحة



## MEASURING INSTRUMENTS



**2348**  
BOLEY Gauge



**2349**  
ZURICHER  
130 mm



**2350**  
VERNIER  
12 cm



**2351**  
VERNIER



**2352**  
VERNIER Gauge



**2353**  
VERNIER Gauge



**2355**  
Finger Ruler



**2354**  
LWANSON  
Crown Gauge



**2356**  
LWANSON  
Crown Gauge



**2357**  
Sliding Gauge  
10 cm



**2358**  
Spring Bow Divider  
6" Radius



**2359**  
VERNIER  
Gauge



**2360**  
ALBEE



**2361**  
Height Gauge  
Wick Type



# MOSSIDENT

Dental Surgical Instruments Supplier

Surgery Instruments  
instrumentos de cirugia  
instruments de chirurgie  
ascensori per radici  
أدوات الجراحة



## BONE GAUGE & MEASURING INSTRUMENTS



**2362**  
Bone Gauge



**2363**  
Bone Caliper  
15 cm



**2364**  
Castroviejo



**2365 A**  
Castroviejo  
Curved



**2365 B**  
Straight



**2366 C**  
Castroviejo  
Straight

**2366 D**  
Curved



**2367**  
Gauge



**2369**  
Curved



**2370 A**

**2371**  
Curved



**2373**  
Boone - Gauge

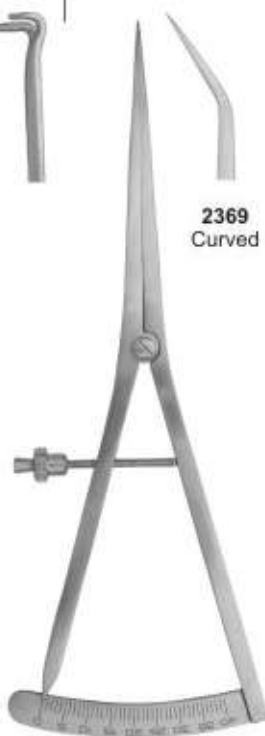

**2368**  
Castroviejo  
Straight

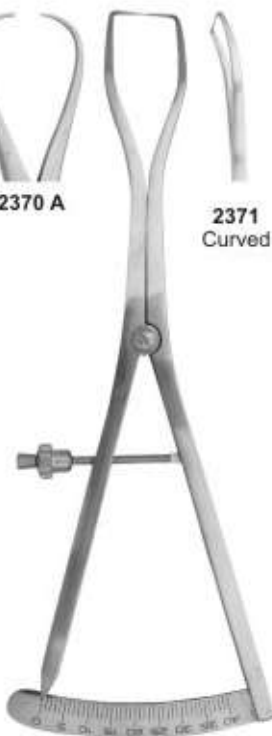

**2370**  
Castroviejo  
Straight



**2372**  
Castroviejo



**2374**  
Curved



**2375**  
Straight



**2376**  
Bracket Gauge. Ant/Pt





# MOSSIDENT

Dental Surgical Instruments Supplier

Surgery Instruments  
instrumentos de cirugia  
instruments de chirurgie  
ascensori per radici  
أدوات الجراحة



## AMALGAM GUNS & CARRIERS



**2377**  
Medium-Large  
20 cm



**2378**  
Medium-Jumbo  
20 cm



**2379**  
Large-Jumbo  
20 cm

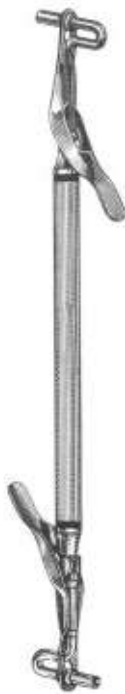

**2380**  
Jumbo-Jumbo  
20 cm



**2381**  
Regular-Jumbo  
Silicon Grip  
20 cm

Ø 2 mm



**2382**  
Medium  
15.5 cm

Ø 2.5 mm



**2383**  
Large  
15.5 cm

Ø 3 mm



**2384**  
Jumbo  
15.5 cm



**2385**  
145 mm



**2386**  
130 mm



Ø 2 mm



Ø 2 mm  
**2387**  
Straight  
15 cm



Ø mm  
**2388**  
15 cm



**2389**  
15 cm  
90°



**2390**  
Amalgam Well  
Non Skid Base  
Ø 3.5 mm





**RETAINERS, BANDS, STRIP HOLDER, NAPKIN HOLDER**



**2391**  
No. 1



**2392**  
No. 8



**2393**  
No. 9

**"Tofflemire" Type Retainers**



**2394**  
JUNIOR-CA



**2395**  
SENIOR-CA



**2396**  
UNIVERSAL

**Tofflemire Bands**

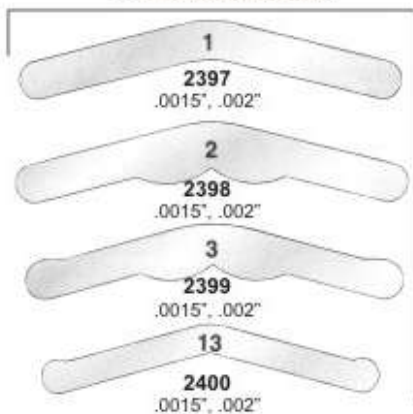

**2401**  
X-Ray Holder  
Small



**Set of 10**  
**2402**  
Film Hanger

**Napkin Holders**



**2403**  
BALL CHAIN



**2404**  
NON-CHILL  
Clear Plastic

**Strip Holders**



**2408**  
Strip Holder Clip  
90°



**2409**  
Strip Holder Clip  
45°



**2405**  
Finger Protector  
Small



**2406**  
Medium



**2407**  
Large



# MOSSIDENT

Dental Surgical Instruments Supplier

Surgery Instruments  
instrumentos de cirugia  
instruments de chirurgie  
ascensori per radici  
أدوات الجراحة



## RUBBER DAM INSTRUMENTS



**2410**  
IRORY  
Light weight, 170 mm



**2411**  
BREWER  
175 mm



**2412**  
BREWER  
175 mm



**2413**  
WHITE  
175 mm



**2414**  
IVORY  
170 mm



**2415**  
AINSWORTH  
Rubber Dam Punch  
170 mm



**2416**  
AINSWORTH  
Rubber Dam Punch  
170 mm



**2417**  
AINSWORTH  
Rubber Dam Punch  
170 mm

### Articulating Paper Forceps



**2421**  
MILLER  
Articulating  
Forceps  
15 cm



**2422**  
MILLER  
Articulating  
Forceps  
15 cm



**2418**  
"IV" Type  
Rubber Dam Punch  
160 mm



**2419**  
Plastic Rubber Dam  
Frame 242

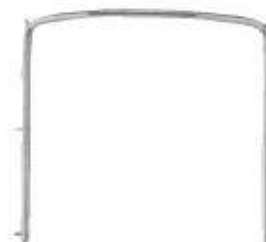

**2420**  
Rubber Dam Holder  
Stainless Steel Pins



**MOSSIDENT**  
Dental Surgical Instruments Supplier

Surgery Instruments  
instrumentos de cirugia  
instruments de chirurgie  
ascensori per radici  
أدوات الجراحة



**RUBBER DAM CLAMPS**

**ENGLISH PATTERN**

**LOWER MOLARS**



**2423**  
76D-W3



**2424**  
76D-3

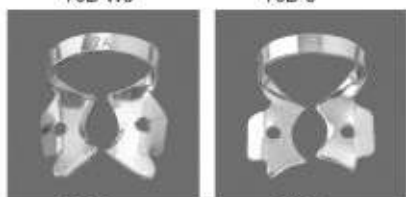

**2429**  
76D-7A



**2430**  
76D-7



**2435**  
76D-12A



**2436**  
76D-13A

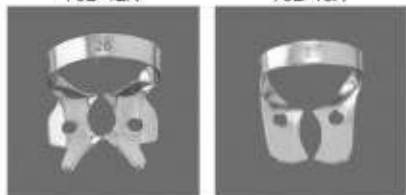

**2441**  
76D-26



**2442**  
76D-28



**2445**  
76D-W8A



**2446**  
76D-8A

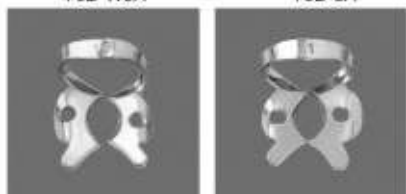

**2447**  
76D-10



**2448**  
76D-11



**2451**  
76D-24



**2452**  
76D-25

**UPPER MOLARS**

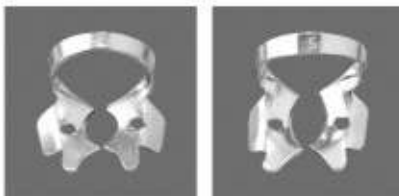

**2425**  
76D-4



**2426**  
76D-5



**2431**  
76D-8



**2432**  
76D-26N



**2437**  
76D-30



**2438**  
76D-31



**2443**  
76D-201



**2444**  
205

**PREMOLARS**



**2427**  
76D-0



**2428**  
76D-1

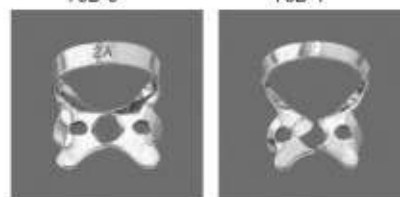

**2433**  
76D-2A



**2434**  
76D-2



**2439**  
76D-27N



**2440**  
76D-29

**ANTERIOR**



**2456**  
76D-00



**2457**  
76D-1A

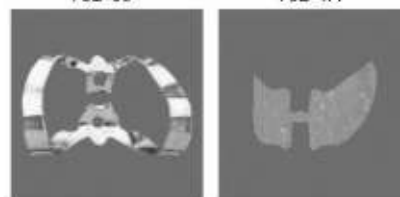

**2458**  
76D-9



**2459**  
76D-212

**MOLARS**

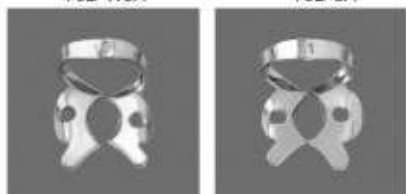

**2449**  
76D-14



**2450**  
76D-118



**2453**  
76D-27



**2454**  
76D-56



**2455**  
76D-14A





**MOSSIDENT**  
Dental Surgical Instruments Supplier

Surgery Instruments  
instrumentos de cirugia  
instruments de chirurgie  
ascensori per radici  
أدوات الجراحة



## ASPIRATING SYRINGES

4969/CO



4969/F



4969/CV



**2460**  
ml 1,8  
EU



**2461**  
ml 1,8  
EU/AM



**2462**  
ml 1,8  
EU/AM



**2463**  
Fig. 1  
ml 1,8  
EU



**2464**  
Fig. 1  
ml 1,8  
EU



**2465**  
SS INOX  
All inox & autoclavable  
black plastic handle  
passive automatic  
aspiration.



**2466**  
Fig. 1  
ml 1,8  
EU/Am



**2467**  
Fig. 1  
ml 1,8  
EU/Am



**2468**  
Fig. 1  
ml 1,8  
EU/Am



**2469**  
ml 1,2  
EU/Am





**SYRINGES**

**ENGLISH PATTERN**



**2470**  
Water Syringe  
complete with  
1 cannula (Lure-Lock)



**2471**  
Water Syringe  
complete with  
1 cannula (Lure-Lock)



**2472**  
Metal Water Syringe  
self-filling, with 1  
cannula (Lure-Lock)



**2473**  
Sparrel Barrel with  
plunger suitable for  
syringes



**2474**  
Cannula, only, with  
Luer-Lock connector  
suitable for syringes



**2475**  
Articulating  
Barrel Syringe



**2476**  
ml 1,8



**2477**  
ml 1,8



**2478**



**2479**



**2480**



**2481**  
Fig. 1  
ml 1,8 EU



**2485**  
Fig. 1  
ml 1,8 EU



**2482**  
Water  
point



**2483**  
Water  
point



**2484**  
Water  
poi



# MOSSIDENT

Dental Surgical Instruments Supplier

Surgery Instruments  
instrumentos de cirugia  
instruments de chirurgie  
ascensori per radici  
أدوات الجراحة



## DENTAL TWEEZERS



**2486**  
ADSON  
Curved 14 cm



**2487**  
ADSON  
1X2 / 12 cm



**2488**  
ADSON  
12 cm



**2489**  
MICRO ADSON  
15 cm



**2490**  
STANDARD  
14, 18, 25 cm



**2491**  
CUSHING  
18 cm



**2492**  
Curved



**2493**  
SELECT  
15, 18, 20 cm



**2494**



**2495**  
MCINDOE  
15 cm



**2496**  
GILLIES  
15 cm



**2497**  
WAUGH  
15, 20 cm

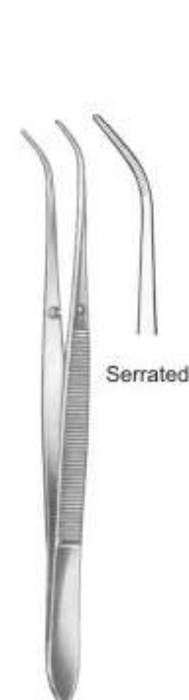

**2498**  
PERRY  
13 cm



**2499**  
KOPP  
15.5 cm



# MOSSIDENT

Dental Surgical Instruments Supplier

Surgery Instruments  
instrumentos de cirugia  
instruments de chirurgie  
ascensori per radici  
أدوات الجراحة



## DENTAL TWEEZERS



**2500**  
COLLEGE  
15 cm



smooth



**2501**  
COLLEGE  
15 cm



serrated



**2502**  
COLLEGE  
15 cm



smooth



**2503**  
COLLEGE  
15 cm



serrated



**2504**  
COLLEGE  
15 cm



smooth



**2505**  
COLLEGE  
15 cm



serrated



**2506**  
COLLEGE  
15 cm



smooth



**2507**  
COLLEGE  
15 cm



serrated



**MOSSIDENT**  
Dental Surgical Instruments Supplier

Surgery Instruments  
instrumentos de cirugia  
instruments de chirurgie  
ascensori per radici  
أدوات الجراحة



## DENTAL TWEEZERS



**2508**  
MERIAM  
16 cm



smooth



**2509**  
MERIAM  
16 cm



serrated



**2510**  
MERIAM  
16 cm



smooth



**2511**  
MERIAM  
16 cm1



serrated



**2512**  
MERIAM  
16 cm



smooth



**2513**  
MERIAM  
16 cm



serrated



**2514**  
MERIAM  
16 cm



smooth



**2515**  
MERIAM  
16 cm



serrated





# MOSSIDENT

Dental Surgical Instruments Supplier

Surgery Instruments  
instrumentos de cirugia  
instruments de chirurgie  
ascensori per radici  
أدوات الجراحة



## DENTAL TWEEZERS

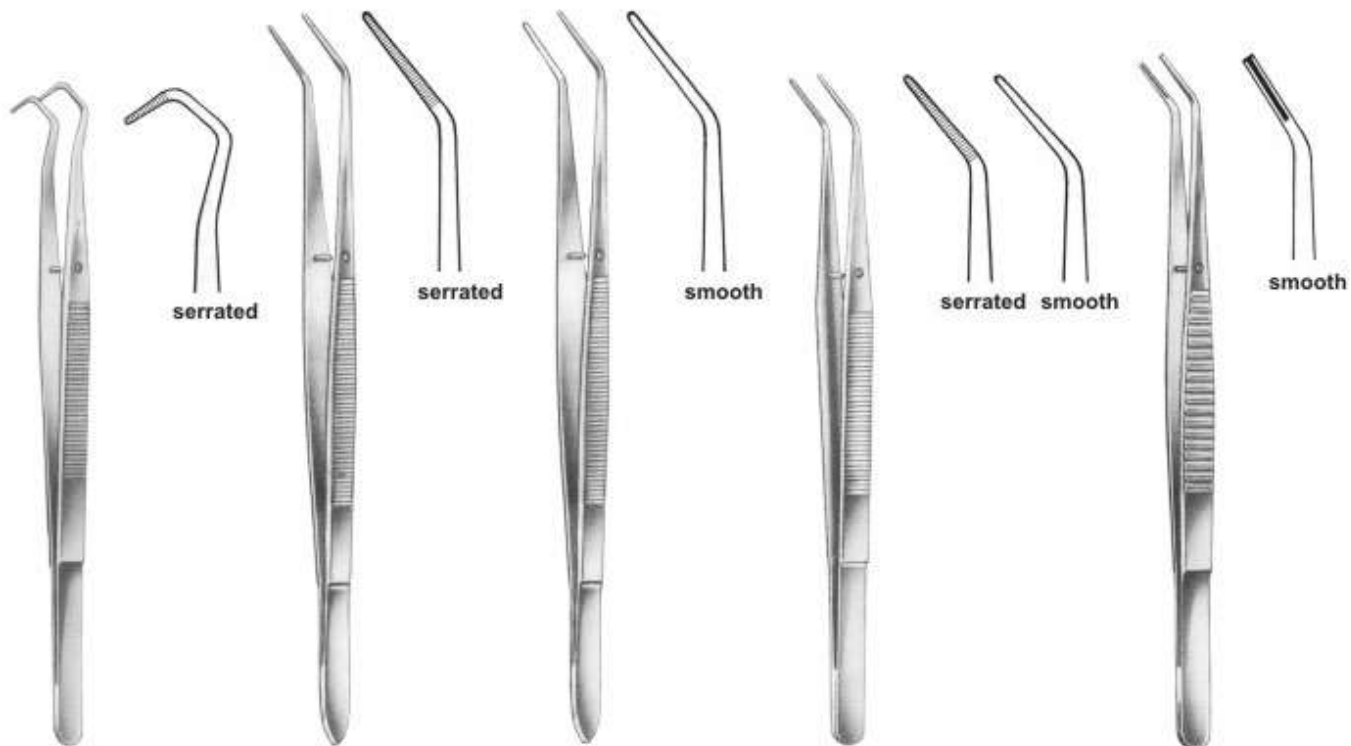

**2516**  
COLLEGE  
14.5 cm, 5<sup>3</sup>/<sub>4</sub>"

**2517**  
FLAGG  
16 cm, 6<sup>1</sup>/<sub>4</sub>"

**2518**  
FLAGG  
16 cm, 6<sup>1</sup>/<sub>4</sub>"

**2519**  
LANDGRAF  
15 cm, 6"

**2520**  
15,5 cm, 6<sup>1</sup>/<sub>8</sub>"

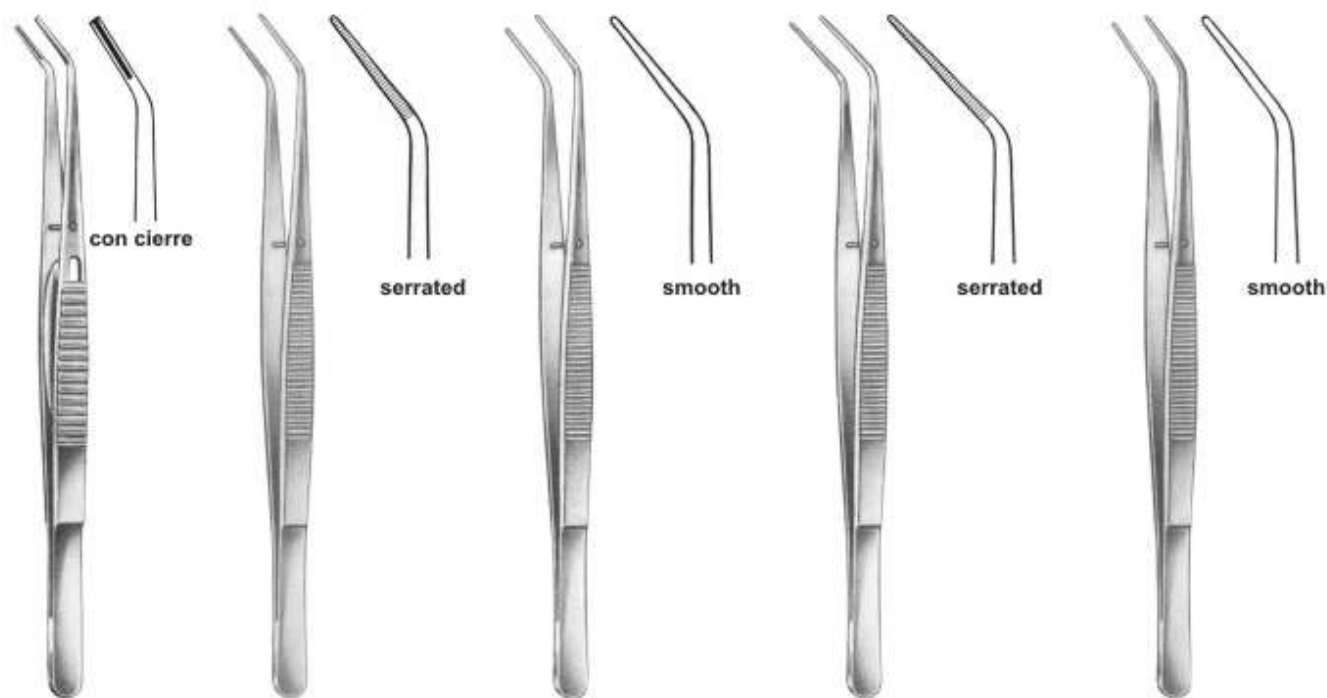

**2521**  
15.5 cm, 6<sup>1</sup>/<sub>8</sub>"

**2522**  
LONDON-COLLEGE  
15 cm, 6"

**2523**  
LONDON-COLLEGE  
15 cm, 6"

**2524**  
LONDON-COLLEGE  
15 cm, 6"

**2525**  
LONDON-COLLEGE  
15 cm, 6"



# MOSSIDENT

Dental Surgical Instruments Supplier

Surgery Instruments  
instrumentos de cirugía  
instruments de chirurgie  
ascensori per radici  
أدوات الجراحة



## DENTAL TWEEZERS



**2526**  
LONDON-COLLEGE  
15 cm, 6"



**2527**  
LONDON-COLLEGE  
15 cm, 6"



con cierre



**2528**  
MERIAM  
16 cm, 6 1/4"



serrated



smooth



**2529**  
ALLEN  
18 cm, 7 1/8"



**2530**  
ALBRECHT  
16 cm, 6 1/4"



**2531**  
ALBRECHT  
16 cm, 6 1/4"



**2532**  
16 cm, 6 1/4"



**2533**  
16 cm, 6 1/4"



**2534**  
16 cm, 6 1/4"





# MOSSIDENT

Dental Surgical Instruments Supplier

Surgery Instruments  
instrumentos de cirugia  
instruments de chirurgie  
ascensori per radici  
أدوات الجراحة



## STERILIZING & LAB INSTRUMENTS



**2535**  
DAVIS  
6"



**2536**  
Grasping Forceps  
6 1/4"



**2537**  
Mesh Bur & Diamond Holder  
Large, 2 1/8" Diameter



**2538**  
Soldering Tweezers  
6 1/4"



**2539**  
Narrow Fine  
4 3/4"



**2540**  
Super Fine  
4 3/8"



**2541**  
Fine Curved  
4 1/2"



**2542**  
Bonding Bracket  
Holder  
136 mm



**2543**  
Bonding Bracket  
Holder  
135 mm



**2544**  
Bonding Bracket  
Holder  
135 mm



**2545**  
Bonding Bracket  
Holder  
140 mm



# MOSSIDENT

Dental Surgical Instruments Supplier

Surgery Instruments  
instrumentos de cirugia  
instruments de chirurgie  
ascensori per radici  
أدوات الجراحة



## ENDODONTIC FORCEPS



**2546**  
Endo Forceps  
4 3/4"



**2547**  
PEETS Forceps  
4 3/4", Useful For  
Removing Broken  
Instruments

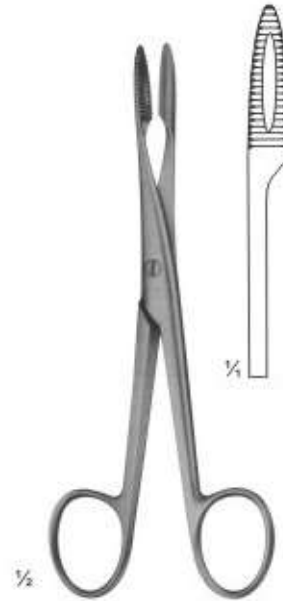

**2548**  
Without Ratchet  
145 mm

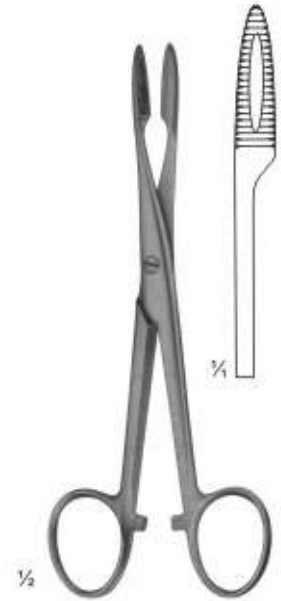

**2549**  
With Ratchet  
145 mm



**2550**  
CRILE  
140 mm

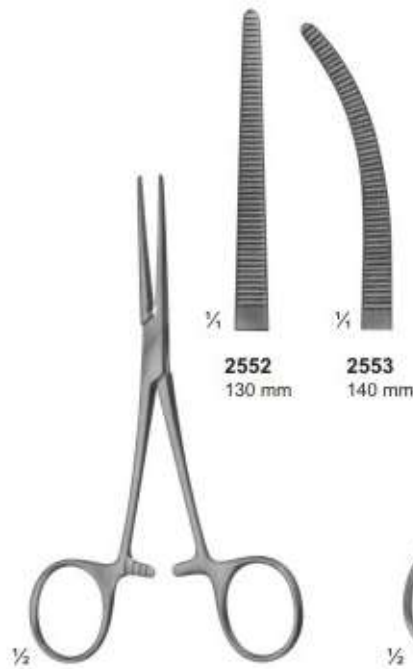

**2551**  
PEAN  
Slender type



**2554**  
SPENCER-WELLS

**2552**  
130 mm

**2553**  
140 mm

**2554**  
130 mm

**2555**  
150 mm

**2556**  
130 mm

**2557**  
150 mm





# MOSSIDENT

Dental Surgical Instruments Supplier

Surgery Instruments  
instrumentos de cirugia  
instruments de chirurgie  
ascensori per radici  
أدوات الجراحة



## TISSUE FORCEPS



**2558**  
BABY-ALLIS  
5", Straight  
4x5 teeth extra delicate



**2559**  
ALLIS  
6", Straight  
4x5 teeth extra delicate



**2560**  
ALLIS  
6", Straight  
4x5 teeth extra delicate



**2561**  
1x2 teeth  
6"



**2562**  
SEMKIN  
6", Straight,  
1x2 teeth



**2563**  
ADSON  
4 3/4"  
1x2 teeth



**2564**  
BROWN-ADSON  
4 3/4"  
7x7 teeth



**2565**  
BROWN  
6"  
8x8 teeth



**2566**  
RUSSIAN  
6"  
8x8 teeth



**2567**  
Extra-Delicate,  
Straight, 4"  
1x2 teeth



# MOSSIDENT

Dental Surgical Instruments Supplier

Surgery Instruments  
instrumentos de cirugia  
instruments de chirurgie  
ascensori per radici  
أدوات الجراحة



## HEMOSTATIC FORCEPS, TOWEL CLAMPS, NAPKIN HOLDER



**2568**  
HALSTED-MOSQUITO  
Straight, Curved, 5"



**2569**  
HALSTED-MOSQUITO  
Straight, Curved, 5"  
1x2 teeth



**2570**  
HALSTED-MOSQUITO  
Jaws 45 Angled on Flat, 5"  
Extra Delicate



**2571**  
KELLY  
5 1/2", Straight



**2572**  
JONES  
3 1/2"



**2573**  
BACKHAUS  
3 1/2"



**2574**  
BACKHAUS  
5 1/4"



**2575**  
LORNA  
Non Perforated  
3 1/2"



# MOSSIDENT

Dental Surgical Instruments Supplier

Surgery Instruments  
instrumentos de cirugia  
instruments de chirurgie  
ascensori per radici  
أدوات الجراحة



## RETRECTORS, DEPRESSORS, MOUTH GAGS



**2576**  
DENHART



**2577**  
DENHARDT  
Mouth Gag With  
Silicon Inserts,  
Interchangeable  
Size: 125 mm

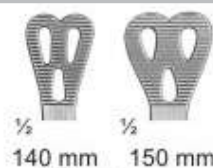

$\frac{1}{2}$  140 mm  $\frac{1}{2}$  150 mm



$\frac{1}{2}$

**2578**  
WIEDER  
Tongue depressor  
**2579** 140mm  
**2580** 150mm



$\frac{1}{2}$

**2581**  
TOBOLD  
Tongue depressor  
Size: 145 mm



$\frac{1}{2}$

**2582**  
ANDREW  
Tongue depressor  
Size: 110 mm



$\frac{1}{2}$

**2583**  
WEITLANER  
Sharp  
130 mm

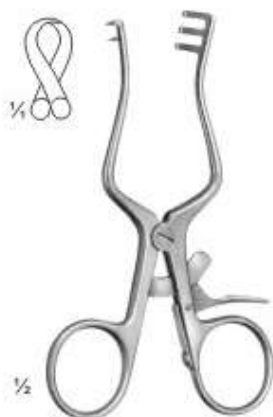

$\frac{1}{2}$

**2584**  
WEITLANER  
Sharp  
110 mm

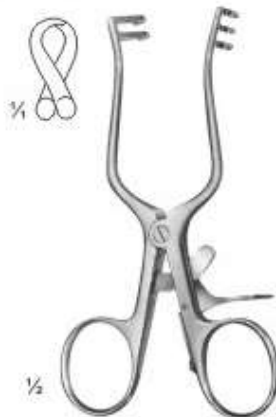

$\frac{1}{2}$

**2585**  
WEITLANER  
Semi-Sharp  
110 mm



**2586**  
MOLT  
Pediatric



**2587**  
MOLT  
Child



**2588**  
MOLT  
Adult



$\frac{1}{2}$

**2589**  
FERGUSSON-ACKLAND  
Mouth Gag  
Size: 145 mm



$\frac{1}{2}$

**2590**  
ROSER KOENIG  
Mouth Gag  
Size: 160mm / 185mm



# MOSSIDENT

Dental Surgical Instruments Supplier

Surgery Instruments  
instrumentos de cirugia  
instruments de chirurgie  
ascensori per radici  
أدوات الجراحة



## LIP & CHEEK RETRECTORS

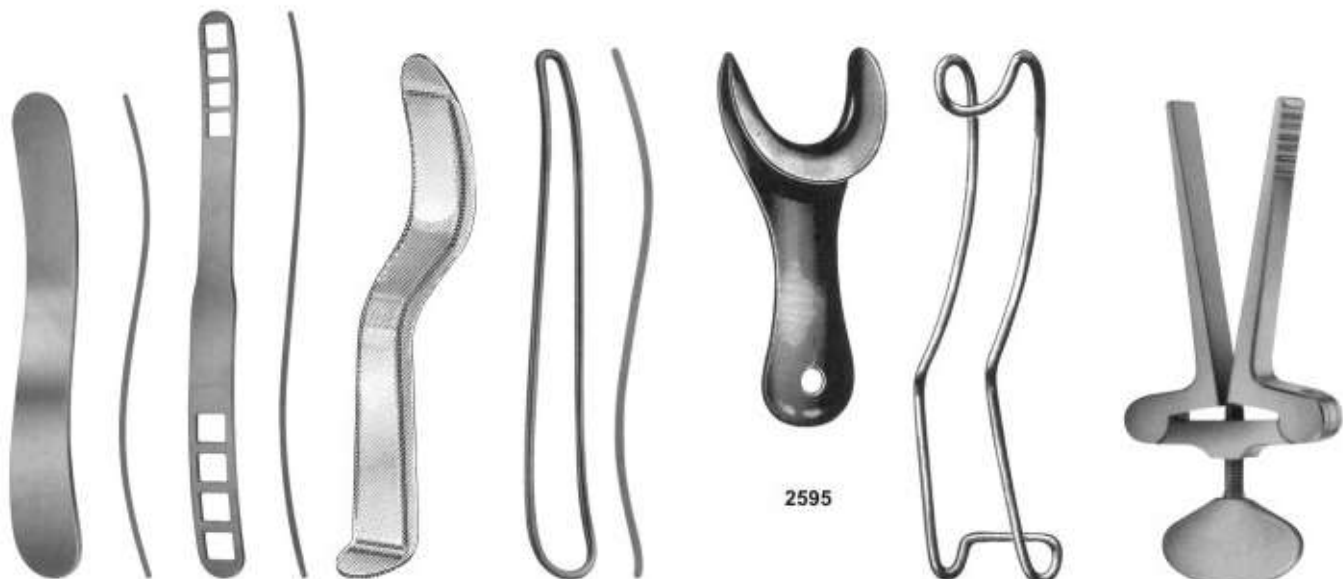

**2591**  
140 mm

**2592**  
BRUENINGS  
190 mm

**2593**

**2594**

**2595**

**2596**

**2597**

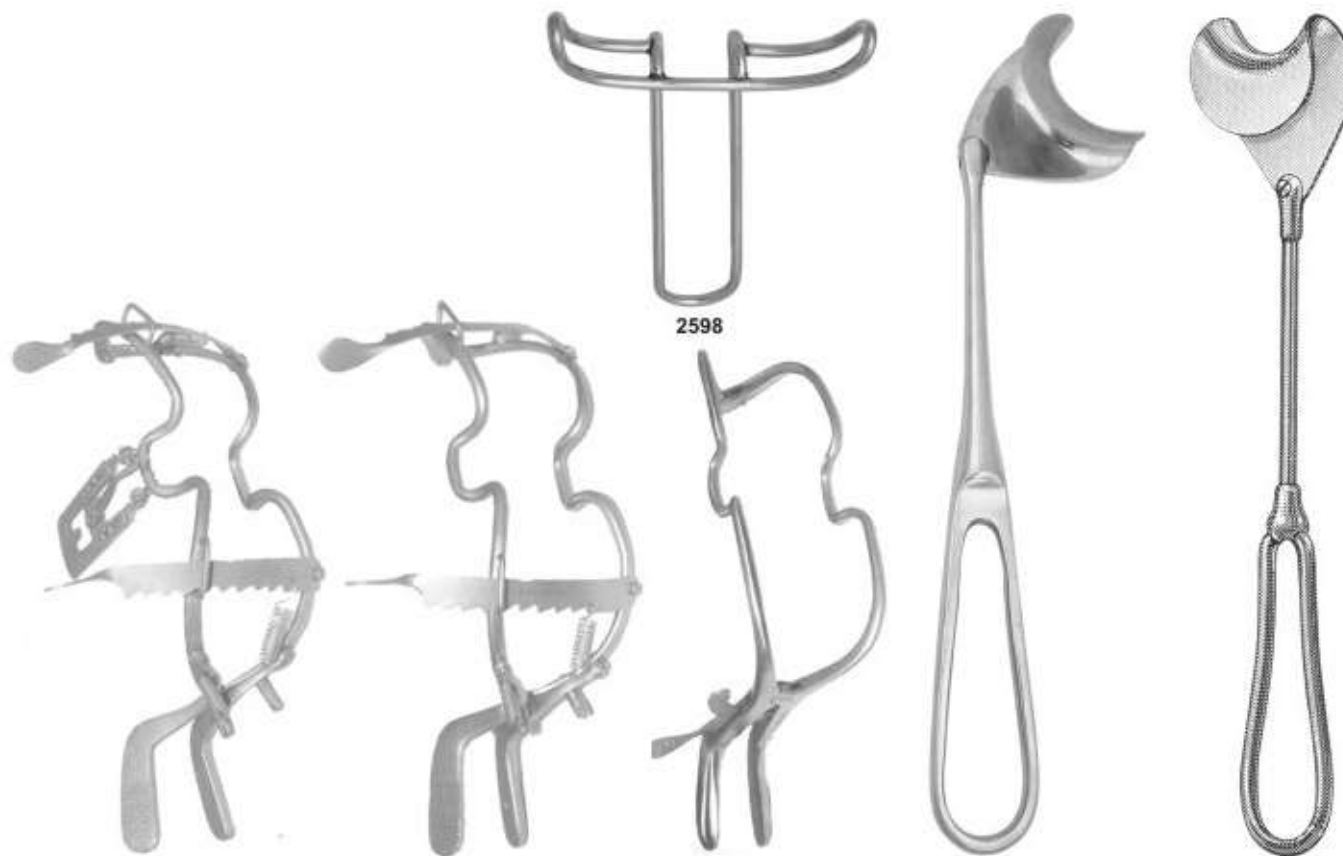

**2598**

**2599**  
Mouth Gag with  
Tongue Depressor  
11.0 cm  
13.0 cm  
15.0 cm

**2600**  
Mouth Gag without  
Tongue Depressor  
11.0 cm  
13.0 cm  
15.0 cm

**2601**  
Jennings, Mouth Gag  
11.0 cm  
13.0 cm  
15.0 cm

**2602**

**2603**





# MOSSIDENT

Dental Surgical Instruments Supplier

Surgery Instruments  
instrumentos de cirugía  
instruments de chirurgie  
ascensori per radici  
أدوات الجراحة



## LIP & CHEEK RETRECTORS

- 30 x 4 mm A
- 23 x 7 mm B
- 24 x 11 mm C
- 29 x 10 mm D
- 30 x 11 mm E
- 32 x 14 mm F
- 40 x 11 mm G
- 42 x 10 mm H
- 50 x 11 mm I
- 55 x 11 mm J
- 60 x 11 mm K
- 70 x 11 mm L
- 70 x 14 mm M



**2604**  
LANGENBECK  
210 mm



**2605**  
KOCHER-LANGENBECK  
215 mm



**2606**  
BUCHS  
205 mm



38 x 18 mm



**2607**  
KOCHER  
230 mm



**2608**  
MIDDELDORPF



**2609**  
15 x 15 mm  
220 mm



**2610**  
20 x 22 mm  
215 mm



**2611**  
28 x 28 mm  
235 mm



**2612**  
KOCHER  
230 mm



**2613**  
COLLIN  
150 mm



**2614**  
ROUX  
Set  
165 mm



# MOSSIDENT

Dental Surgical Instruments Supplier

Surgery Instruments  
instrumentos de cirurgia  
instruments de chirurgie  
ascensori per radici  
أدوات الجراحة



## STERILIZING FORCEPS



**2615**  
Sterilizing Forcep Curved  
20 cm A  
25 cm B  
30 cm C



**2616**  
Sterilizing Forcep Straight  
20 cm A  
25 cm B  
30 cm C



**2617**  
Sterilizing Forcep  
30 cm



**2618**  
Becht Tweezer



**2619**  
Sterilizing Forcep  
23 cm A  
30 cm B



**2620**  
Sterilizing Forcep  
20 cm





**TISSUE RETRECTORS & HOOKS**



**2621**  
3 sharp prongs



**2622**  
2 sharp prongs  
6"



**2623**  
2 sharp prongs  
6"



**2624**  
FOMON  
145 mm



**2625**  
ALM  
70 mm



**2626**  
SENN  
3 sharp prongs  
6 3/8"



**2627**  
TOENNIS  
Dura Retractor  
150mm



**2628**  
JOSEPH  
165 mm



**2629**  
GILLIES  
180 mm



## ORTHODONTIC PLIERS



**2630**  
Light Wire Cutter



**2631**  
Wire Cutter



**2632**  
Posterior Band Remover  
Long



**2633**  
Posterior Band Remover  
Short



**2634**  
Jarabak Plier



**2635**  
Distal End Cutter  
Safety End Cutter



**2636**  
Distal End Cutter



**2637**  
Kim's Plier



**2638**  
Loop Forming Plier



**2639**  
Tweed Arch Bending Plier



**2640**  
Utility Plier



**2641**  
Bonding Bracket Remover



**2642**  
Lingual Arch Plier



**2643**  
Light Wire Plier



**2644**  
Wire Cutter  
12.5 cm





**ORTHODONTIC PLIERS**



**2645**  
Fig. 101  
Wire Bending



**2646**  
Fig. 118  
PEESO  
Collar



**2647**  
Fig. 417  
Crown Shell

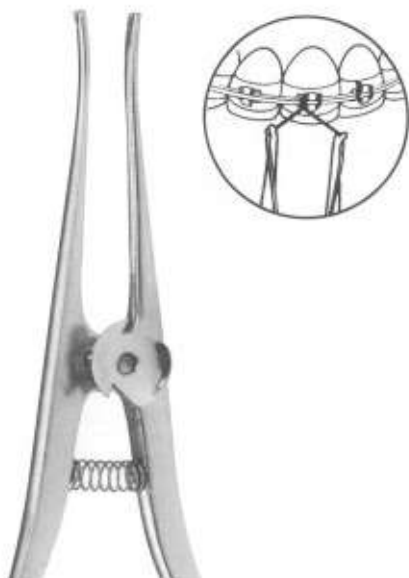

**2648**  
STEINER  
150 mm  
Ligature Pliers

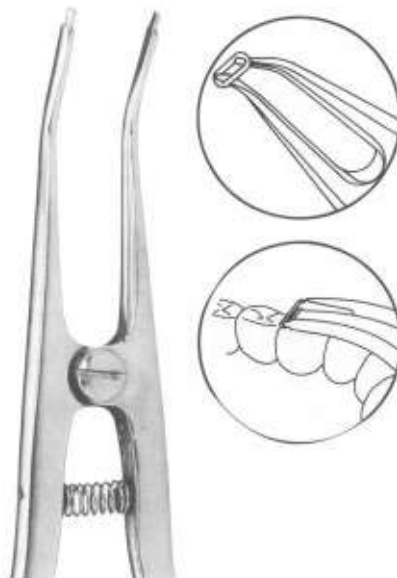

**2649**  
Separating Pliers Elastics  
150 mm



**2650**  
121-Lab & Office



**ORTHODONTIC PLIERS**



**2651**  
How Plier-Titanium Alloy  
With special coated beaks



**2652**  
How Plier  
Tips are 1/8"(3.2mm)  
diameter



**2653**  
How Plier  
Tips are 1/8"(3.2mm)  
diameter



**2654**  
How Plier-Small  
Tips are 3/32"(2.4mm)  
diameter



**2655**  
How Plier-Offset  
Tips are 1/8"(3.2mm)  
diameter



**2656**  
Weingart Utility Plier  
-Titanium Alloy  
with special coated beaks

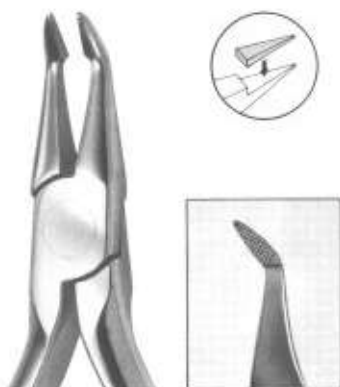

**2657**  
Weingart Utility Plier  
New type of the Weingart Utility Plier  
designed for a more precise operation.



**2658**  
Weingart Utility Plier



**2659**  
Weingart Utility Plier

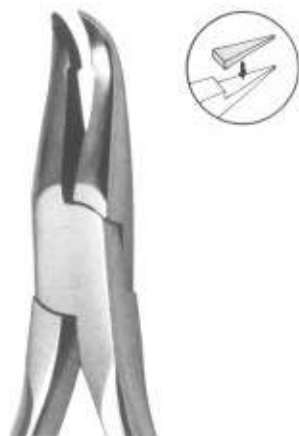

**2660**  
Weingart Utility Plier

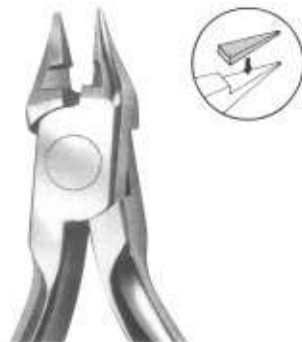

**2661**  
Bird Beak Plier With Cutter  
**Maximum Bending &  
Cutting Capacity:**  
Wires up to .032"



**2662**  
Bird Beak Plier  
**Maximum Bending Capacity:**  
Wires up to .032"



**2663**  
Bird Beak Plier  
**Maximum Bending  
Capacity:**  
Wires up to .030"



**ORTHODONTIC PLIERS**



**2664**  
TWEED (Fig. 98)  
13 cm, 5 1/8"  
Tweed Loop Omega Pliers.

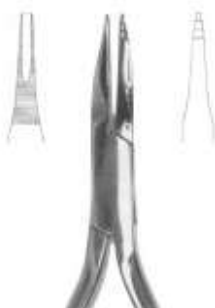

**2665**  
TWEED - (Fig. 90)  
14 cm, 5 1/2"



**2666**  
O'BRIEN - (Fig. 97)  
14 cm, 5 1/2"



**2667**  
TWEED (Fig. 96)  
14 cm, 5 1/2"

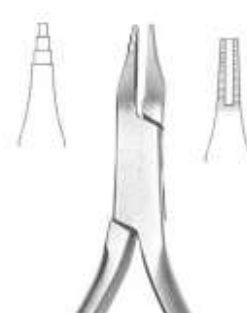

**2668**  
TWEED (Fig. 95)  
13.5 cm, 5 1/4"



**2669**  
SCHWARZ (Fig. 29)  
12.5 cm, 5"



**2670**  
NANCE (Fig. 80)  
13 cm, 5 1/8"



**2671**  
YOUNG (Fig. 55)  
13 cm, 5 1/8"



**2672**  
SCHWARZ (Fig. 30)  
13 cm, 5 1/8"



**2673**  
Optical Plier (Fig. 53)  
14 cm, 5 1/2"

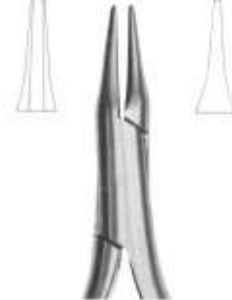

**2674**  
Schwarz (Fig. 79)  
13.5 cm, 5 1/4"



**ORTHODONTIC PLIERS**



**2675**  
NANCE (Fig. 56)  
12.5 cm, 5"  
Wire bending Pliers



**2680**  
14.0 cm  
Goslee Contouring Plier



**2676**  
JOHNSON (Fig. 59)  
13.5 cm, 5 1/4"  
Contouring Plier.



**2677**  
REYNOLDS (Fig. 61)  
13 cm, 5 1/8"  
Contouring Plier.



**2678**  
De La Rosa (Fig. 34)  
12.5 cm, 5"  
Contouring Plier, Non-Grooved



**2679**  
De La Rosa (Fig. 35)  
12.5 cm, 5"  
Contouring Plier, Grooved



**2681**  
14.0 cm  
Goslee Contouring Plier

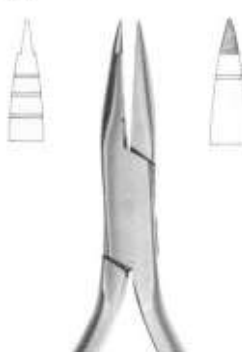

**2682**



**2683**  
Fig. 58  
12.5 cm, 5"  
Lingual Arch Bending Plier



**2684**  
Frevert/Tweed (Fig. 51)  
12.5 cm, 5"  
Tweed Arch Plier/Standard Jaw

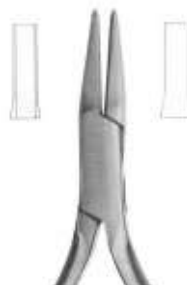

**2685**



**2686**  
ANGLE (Fig. 52)  
13 cm, 5 1/8"  
Arch Formin





**ORTHODONTIC PLIERS**



**2687**  
Fig. 60  
13 cm, 5 1/8"  
Wire & Clasp Bending Pliers



**2688**  
Fig. 60  
13 cm, 5 1/8"  
Wire & Clasp Bending Pliers



**2689**  
Aderer (Fig. 57)  
12 cm, 4 3/4"  
Wire & Clasp Bending Pliers



**2690**  
49 e 49 TC  
14 cm, 5 1/2"  
Band Removing Plier, short pad



**2691**  
50 e 50 TC  
14 cm, 5 1/2"  
Band Removing Plier, long pad



**2692**  
Fig. 84  
14.5 cm, 5 3/4"  
Band pinshing & ligature  
locking plier, serrated



**2693**  
Fig. 72  
14 cm, 5 1/2"  
Band pinshing & ligature  
locking plier, serrated



**2694**  
BRACKET (Fig. 82)  
13.5 cm, 5 1/4"  
Direct Bonding Bracket Remover



**2695**  
BRACKET (Fig. 83)  
13.5 cm, 5 1/4"  
Direct Bonding  
Bracket Remover



# MOSSIDENT

Dental Surgical Instruments Supplier

Surgery Instruments  
instrumentos de cirugia  
instruments de chirurgie  
ascensori per radici  
أدوات الجراحة



## ORTHODONTIC PLIERS



**2696**  
38c, 38TC  
13.5 cm, 5 1/4"  
Contouring closing loop pliers,  
wire bending, cutter.

**2697**  
40c, 40TC  
13.5 cm, 5 1/4"  
Contouring pliers light wire pliers  
grooved with cutter.

**2698**  
Fig. 81  
12.5 cm, 5"  
Sling clasp & wire bending plier



**2699**  
Fig. 28  
14 cm, 5 1/2"  
Sling clasp & wire bending plier.



**2700**  
Fig. 21  
13 cm, 5 1/8"  
Light wires pliers, grooved



**2704**  
46c - 46 TC  
ADAMS - N. 139c  
12.5 cm, 5"  
Bird beak with cutter.



**2701**  
ADAMS, 23, 23TC  
12.5 cm, 5"  
Sling clasp & wire bending plier.



**2702**  
ADAMS (Fig. 33)  
12.5 cm, 5"  
For retaining elements.



**2703**  
ADAMS (Fig. 44)  
12.5 cm, 5"  
Sling clasp & wire bending plier.



**2705**  
Universal Wire Bending  
Pliers (ADAMS) 47 TC, N.64  
12.5 cm, 5"  
Sling clasp & wire bending plier.



**2706**  
86c, 86 TC  
Angle Bird Beak - N.138  
12.5 cm, 5"  
Sling clasp & wire bending plier.



**ORTHODONTIC CUTTER TC**



Ø 1.0 mm  
(0.40")

**2707**  
Fig. 18 TC  
15 cm, 6"



Ø 1.0 mm  
(0.40")

**2708**  
Fig. 92 TC  
14 cm, 5 1/2"



Ø 0.4 mm  
(0.16")

**2709**  
Fig. 91 TC  
13 cm, 5 1/8"



Ø 0.4 mm  
(0.16")

**2710**  
Fig. 99 TC  
13 cm, 5 1/8"



Ø 0.4 mm  
(0.16")

**2711**  
Fig. 94 TC  
13 cm, 5 1/8"  
Angled at 15° with or  
without spring on \  
the handles.



**2712**  
Fig. 85 TC  
13 cm, 5 1/8"



**2713**  
Fig. 87 TC  
13 cm, 5 1/8"



**2714**  
Fig. 85 TC  
Angled at 15°  
13 cm, 5 1/8"



**2715**  
ADAMS 87 TC  
Angled at 15°  
13 cm, 5 1/8"



# MOSSIDENT

Dental Surgical Instruments Supplier

Surgery Instruments  
instrumentos de cirugía  
instruments de chirurgie  
ascensori per radici  
أدوات الجراحة



## ORTHODONTIC DISTAL & CUTTERS







# MOSSIDENT

Dental Surgical Instruments Supplier

Surgery Instruments  
instrumentos de cirugia  
instruments de chirurgie  
ascensori per radici  
أدوات الجراحة



## ORTHODONTIC PLIERS & PROSTHETICS



**2721**  
UNIVERSAL  
150 mm



**2722**  
WALDSACHS  
155 mm



**2723**  
ADERER  
125 mm



**2724**  
NANCE  
125 mm



**2725**  
REYNOLDS  
125 mm



**2726**  
HOW  
145 mm



**2727**  
HOW  
140 mm



**2731**  
FURRER  
150 mm



**2728**  
WALDRON  
125 mm

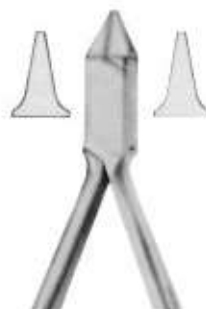

**2729**  
ADAMS  
125 mm



**2730**  
ANGLE  
125 mm

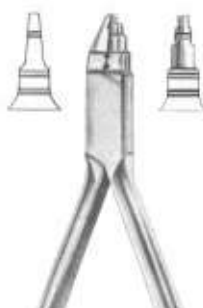

**2732**  
YOUNG  
130 mm



**2733**  
NANCE  
130 mm



# MOSSIDENT

Dental Surgical Instruments Supplier

Surgery Instruments  
instrumentos de cirugia  
instruments de chirurgie  
ascensori per radici  
أدوات الجراحة



## ORTHODONTIC PLIERS & PROSTHETICS



**2734**  
LANGEBECK  
125 mm



**2735**  
LANGEBECK  
140 mm



**2736**  
LANGEBECK  
130 mm

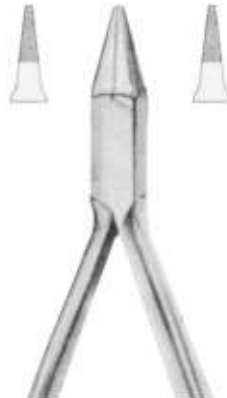

**2737**  
PEESO  
125 mm



**2738**  
GOSLEE  
125 mm



**2739**  
FISCHER  
140 mm



**2740**  
FISCHER  
140 mm



**2741**  
JOHNSON  
130 mm



**2742**  
MSY  
130 mm



**2743**  
MC KELLOPS  
155 mm



**2744**  
ANDRESEN  
130 mm



**2745**  
SCHWARZ  
130 mm



**MOSSIDENT**  
Dental Surgical Instruments Supplier

Surgery Instruments  
instrumentos de cirugia  
instruments de chirurgie  
ascensori per radici  
أدوات الجراحة



**RONGEURS**



**2746**  
BLUMENTHAL  
6", 30°, Standard

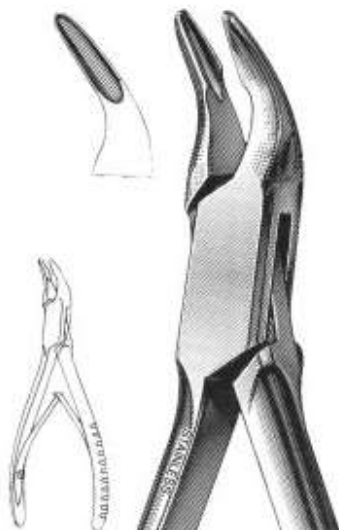

**2747**  
MINI-BLUMENTHAL  
6", 45°

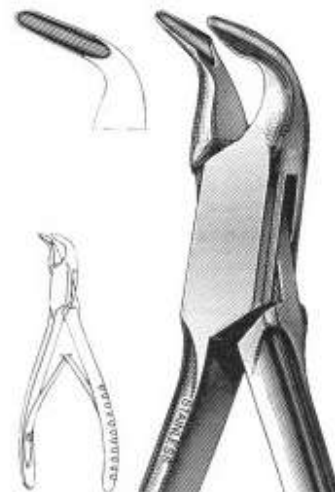

**2748**  
MINI-BLUMENTHAL  
6", 90°

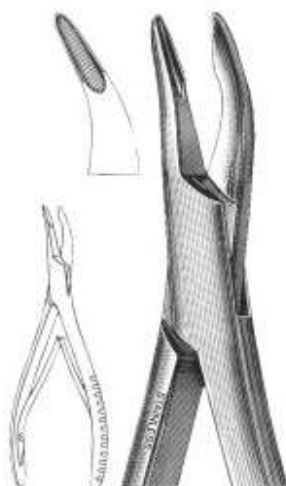

**2749**  
BLUMENTHAL  
7", 30°

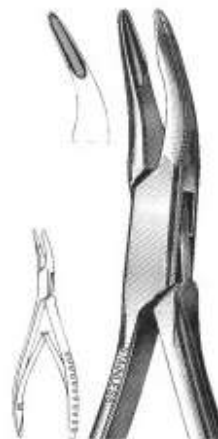

**2750**  
MINI-BLUMENTHAL  
4 1/2", 30°

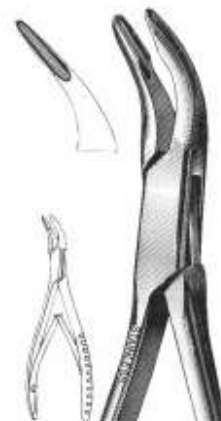

**2751**  
MINI-BLUMENTHAL  
4 1/2", 45°



# MOSSIDENT

Dental Surgical Instruments Supplier

Surgery Instruments  
instrumentos de cirugia  
instruments de chirurgie  
ascensori per radici  
أدوات الجراحة



## RONGEURS



**2752**  
CLEVELAND  
No. 5-Side Cutting,  
6 3/4"

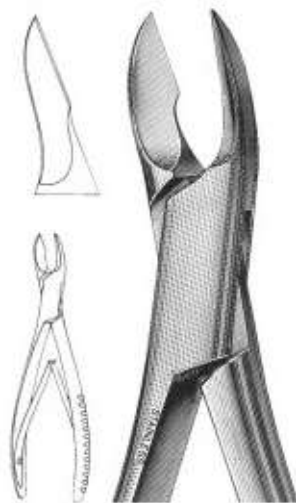

**2753**  
CLEVELAND  
No. 5A-Side Cutting,  
6 1/2"

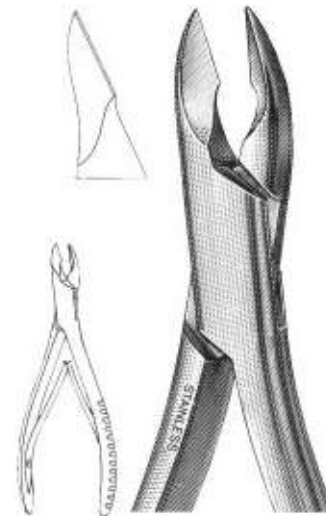

**2754**  
CLEVELAND  
No. 5S-Side Cutting,  
6"

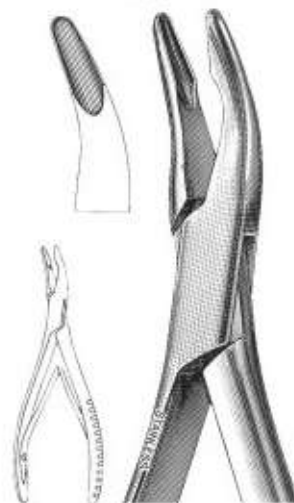

**2755**  
MEAD, Square  
No. 1A-MEAD  
6 1/2"

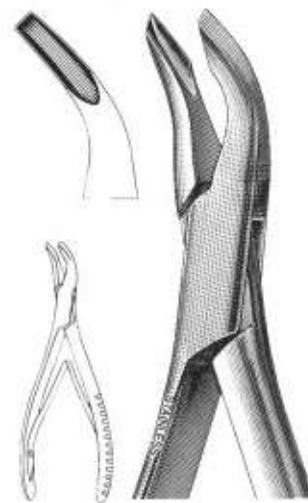

**2756**  
MEAD, Square  
No. 2A  
Tips, 6 1/2"



**2757**





# MOSSIDENT

Dental Surgical Instruments Supplier

Surgery Instruments  
instrumentos de cirugia  
instruments de chirurgie  
ascensori per radici  
أدوات الجراحة



## RONGEURS



**2757**  
FRIEDMAN  
5 1/2"

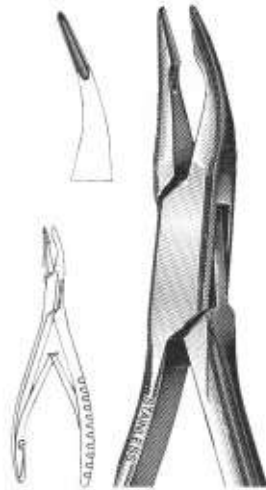

**2758**  
MICRO-FRIEDMAN  
5 1/2", 15° Curved Jaws

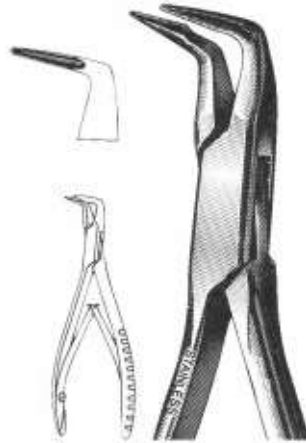

**2759**  
MICRO-FRIEDMAN  
Perio Rongeur, 5 1/2"

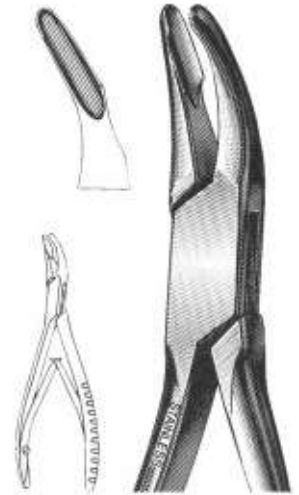

**2760**  
CLEVELAND  
No. 4 - 5 1/2"

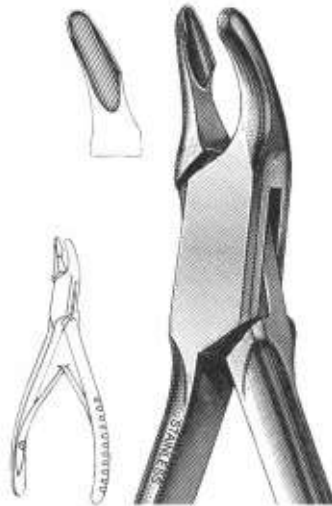

**2761**  
CLEVELAND  
No. 4A - 6 1/2"

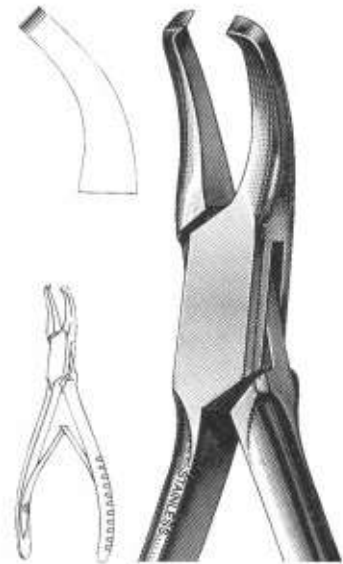

**2762**  
GARDNER  
No. 6A, End Cutting  
6 1/2"



# MOSSIDENT

Dental Surgical Instruments Supplier

Surgery Instruments  
instrumentos de cirugia  
instruments de chirurgie  
ascensori per radici  
أدوات الجراحة



## RONGEURS



**2763**  
BEYER  
Double Action,  
16,18 cm



**2764**  
No. 1  
6 1/2"

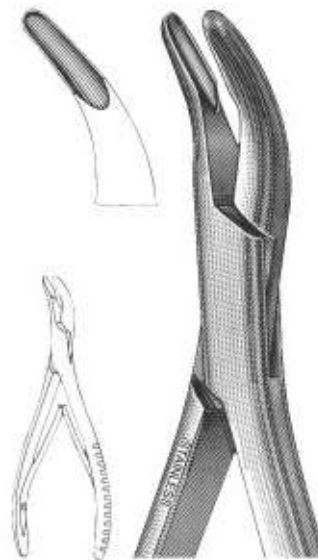

**2765**  
HARTMAN  
5 3/4"  
Strong Curve

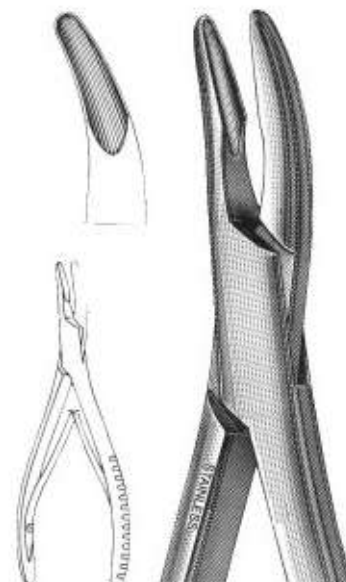

**2766**  
BANE  
Slight Curve  
7"



# MOSSIDENT

Dental Surgical Instruments Supplier

Surgery Instruments  
instrumentos de cirugia  
instruments de chirurgie  
ascensori per radici  
أدوات الجراحة



## NEEDLE HOLDERS



**2767**  
COLLIER  
5", Fenestrated Jaws



**2768**  
DERF  
4 3/4"



**2769**  
WEBSTER  
Delicate Smooth Jaws  
5"



**2770**  
NEIVERT  
One Offset Ring  
5"



**2771**  
OLSEN-HEGAR  
5 1/2"



**2772**  
BAUMGARTNER  
5 1/2"



**2773**  
CRILE-WOOD  
6"



**2774**  
GARDNER  
5"





# MOSSIDENT

Dental Surgical Instruments Supplier

Surgery Instruments  
instrumentos de cirugia  
instruments de chirurgie  
ascensori per radici  
أدوات الجراحة



## NEEDLE HOLDERS



**2775**  
MAYO-HEGAR  
5"



**2776**  
CASTROVIEJO  
Smooth Jaws  
14 cm



**2777**  
CASTROVIEJO  
Smooth Jaws  
14 cm



**2778**  
CASTROVIEJO  
Smooth Jaws  
14 cm



**2778**  
CASTROVIEJO  
Smooth Jaws  
14 cm



**2779 A**  
18 cm



**2780 A**  
18 cm



**2781**  
BOYNTON  
5"



**2782**  
CRILE  
6"



**2783**  
MATHIEU  
5 1/2"



**2784**  
STEVENS  
6 1/2"





# MOSSIDENT

Dental Surgical Instruments Supplier

Surgery Instruments  
instrumentos de cirugia  
instruments de chirurgie  
ascensori per radici  
أدوات الجراحة



## MICRO SURGERY SET



**2785**  
Micro Scissor  
Straight, 155 mm



**2786**  
Micro Scissor  
Straight, 150 mm



**2787**  
Micro Scissor  
Curved, 150 mm



**2788**  
Micro Scissor  
Curved, 155 mm



**2789**  
CASTROVIEJO  
T.C.  
Straight, 180 mm



**2790**  
Retractor  
Fig.3  
165 mm



**2791**  
Micro Adson  
120 mm



**2792**  
GERALD  
Curved,  
180 mm



**2793**  
GERALD  
Straight,  
175 mm



**2794**  
Micro Adson  
160 mm



**2795**  
Micro Surgery Set 10 Pieces.



**SCISSORS**

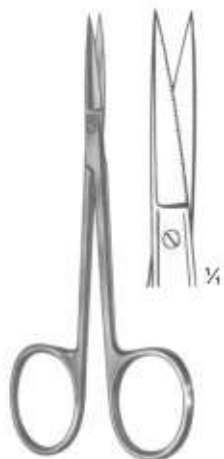

**2796**  
IRIS (Standard)  
Straight  
11.5 cm, 4 1/2"

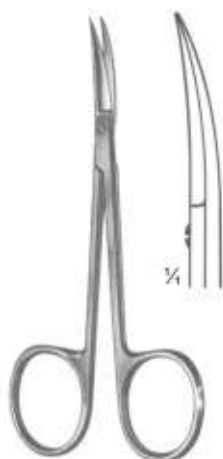

**2797**  
IRIS (Standard)  
Curved  
11.5 cm, 4 1/2"

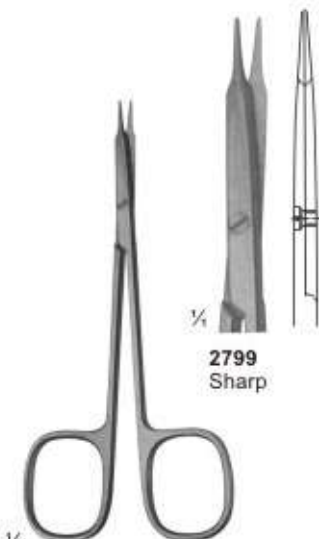

**2799**  
Sharp



**2800**  
Sharp



**2801**  
Blunt



**2802**  
Blunt



**2798**  
STEVENS  
Dissecting Scissors  
Size: 115 mm



**2803**



**2804**  
JOSEPH  
Size: 150 mm

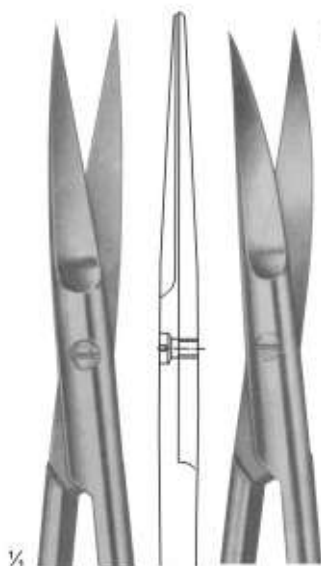

**2805**



**2806**

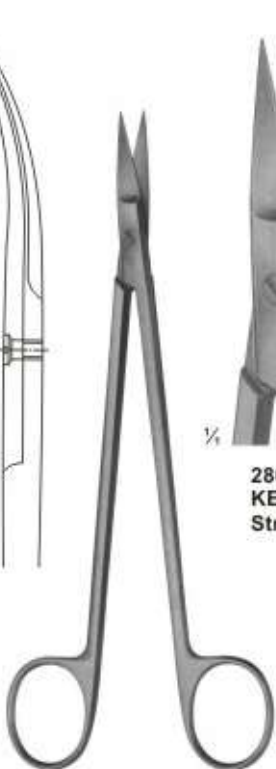

**2807**  
KELLY  
Size: 175 mm



**2808**  
KELLY  
Straight

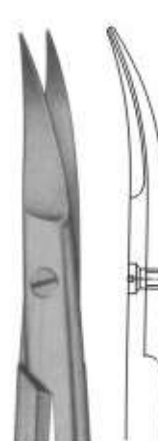

**2809**  
KELLY  
Curved

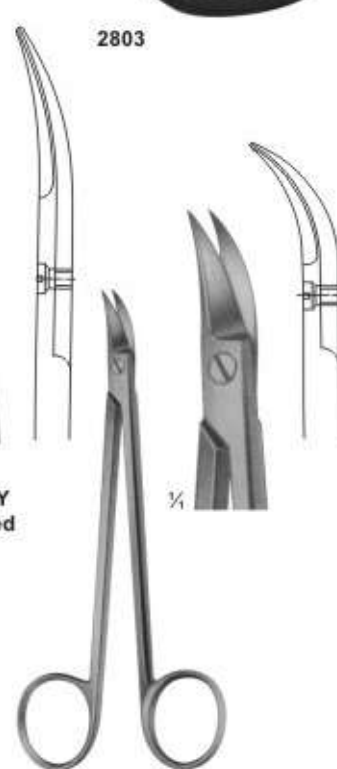

**2810**  
QUINBY  
Size: 130 mm



**SCISSORS**



$\frac{1}{2}$   
**2811**  
Standard - Types  
Size: 115 mm



$\frac{1}{2}$   
**2812**  
DEAVER  
With flat lock



$\frac{1}{4}$   
**2813**  
Size: 145 mm



$\frac{1}{4}$   
**2814**  
Size: 145 mm



$\frac{1}{4}$   
**2815**  
Size: 145 mm

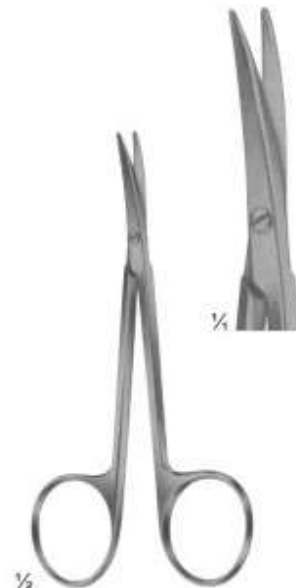

$\frac{1}{2}$   
**2816**  
LITTLER  
Dissecting Scissors  
Size: 115 mm



$\frac{1}{2}$   
**2817**  
COTTLE  
Bulldog Scissors  
Size: 115 mm

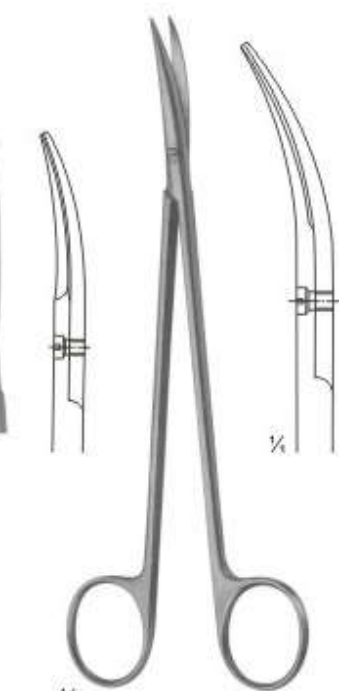

$\frac{1}{2}$   
**2818**  
DE BAKEY  
Ateriectomy scissors  
Size: 175 mm

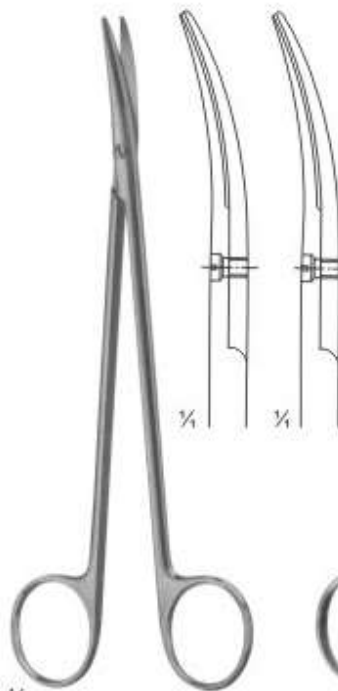

$\frac{1}{2}$   
**2819**  
TOENNIS - ADSON  
Dissecting scissors  
Size: 175 mm

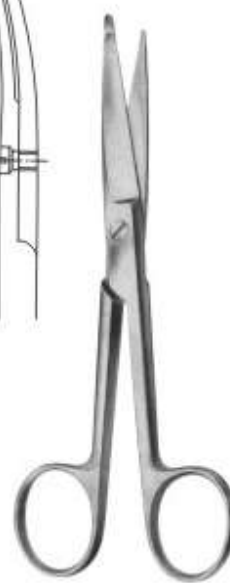

$\frac{1}{2}$   
**2820**  
KNOWLES  
Size: 145 mm



$\frac{1}{2}$   
**2821**  
LISTER



**SCISSORS**

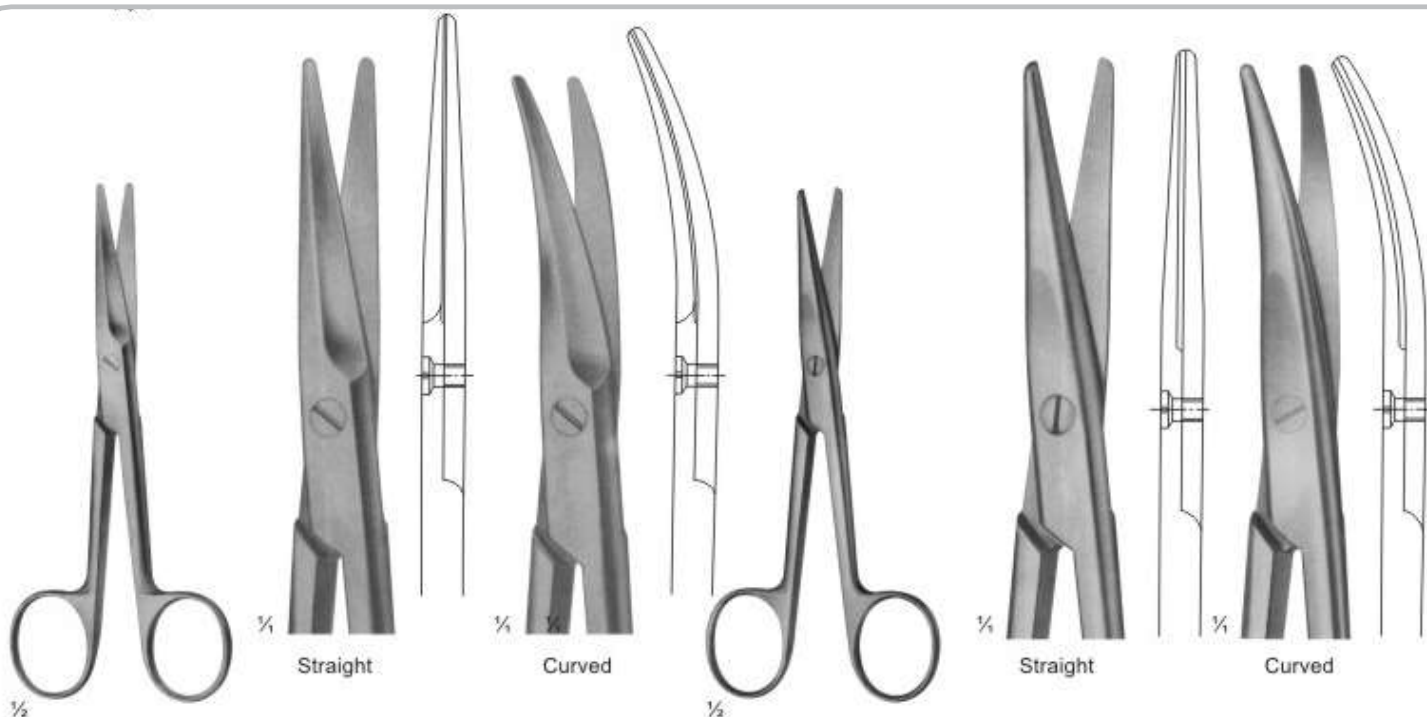

**2822**  
MAYO(straight)  
Size: 140 mm

**2823**  
MAYO-STILLE (straight)  
Size: 140 mm

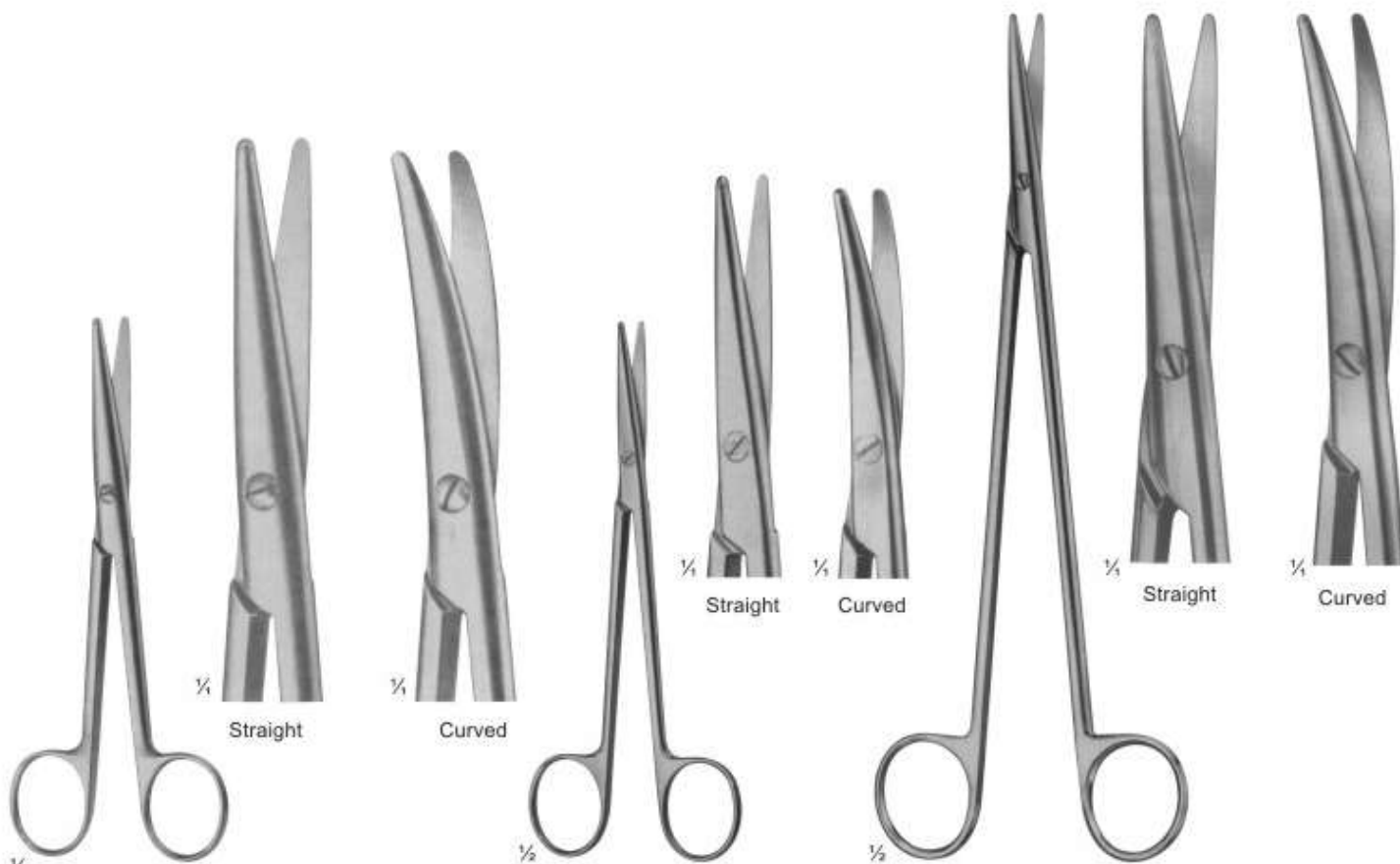

**2824**  
STILLE  
Size: 140 mm

**2825**  
METZENBAUM  
Size: 145 mm

**2826**  
NELSON-METZENBAUM  
Size: 230 mm





# MOSSIDENT

Dental Surgical Instruments Supplier

Surgery Instruments  
instrumentos de cirugia  
instruments de chirurgie  
ascensori per radici  
أدوات الجراحة



## SCISSORS

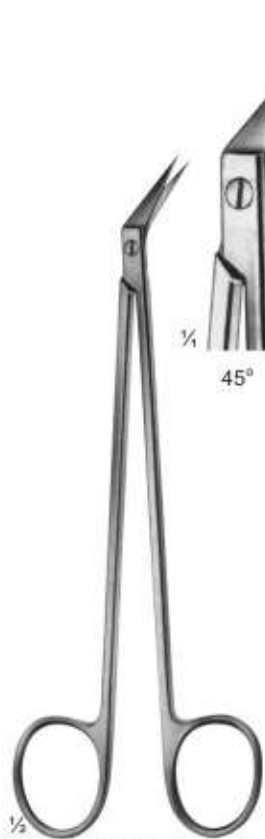

**2827**  
DE BAKEY  
Size: 155 mm



**2828**  
LOCKLIN  
Curved Sideways,  
1 Toothed Blade  
Size: 155 mm

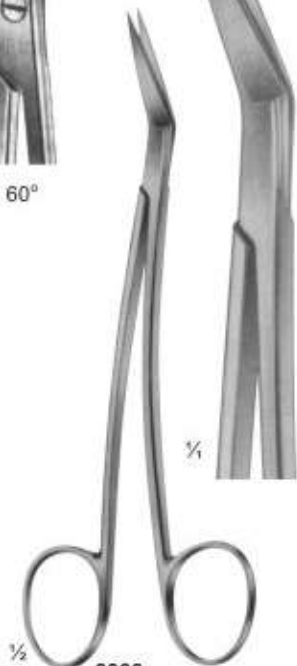

**2829**  
LaGrange  
Double-Curved  
11.5 cm



**2830**  
Goldman-Fox  
Double-Curved  
13cm



**2831**  
SPENCER  
Size: 90 mm



**2832**  
LITTAUER  
Size: 135 mm

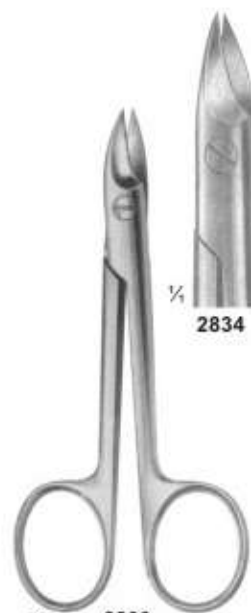

**2833**  
BEEBE  
Size: 110 mm



**2834**



**2835**



**2836**



**2837**



**2838**  
Dean  
17cm



**2839**  
1 Blade Serrated  
Size: 120 mm

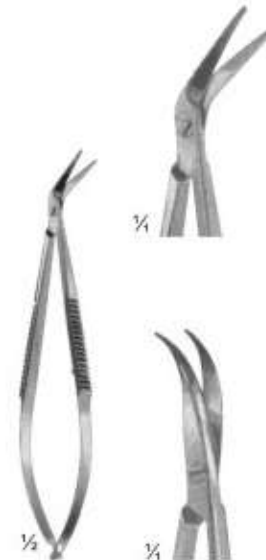

**2840**  
CASTROVIEJO  
Size: 90



**IMPRESSION TRAYS**

Made of 18/8 Stainless Steel, Solid, Set of 10



2841  
U1



2842  
U2



2843  
U3



2844  
U4



2845  
U5



2846  
L1



2847  
L2



2848  
L3



2849  
L4



2850  
L5

All The Above Impression Trays are Available in These 5 Sizes

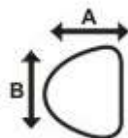

UPPER		U1	U2	U3	U4	U5
	A	62	60	53	54	52
B	83	75	73	69	68	

All Dimension are in mm

LOWER		L1	L2	L3	L4	L5
	A	63	61	57	60	53
B	82	81	78	74	71	

All Dimension are in mm

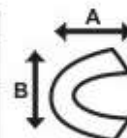

Perforated, Set of 10



2851  
U1



2852  
U2



2853  
U3



2854  
U4



2855  
U5



2856  
L1



2857  
L2



2858  
L3



2859  
L4



2860  
L5



**IMPRESSION TRAYS**

Made of 18/8 Stainless Steel, Solid Full Denture Set of 8

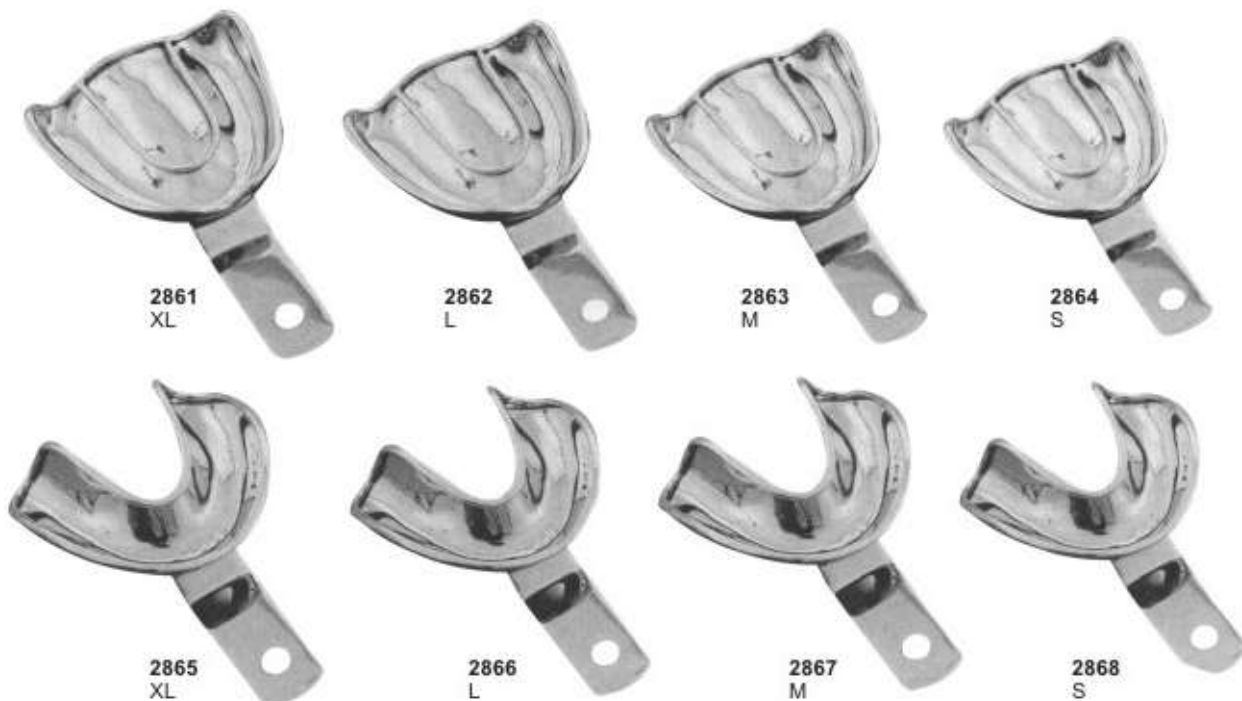

All The Above Impression Trays are Available in These 4 Sizes

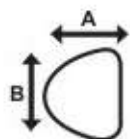

UPPER		XL	L	M	S
	A	70	67	64	60
B	79	76	70	73	

All Dimension are in mm

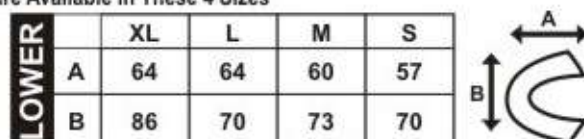

LOWER		XL	L	M	S
	A	64	64	60	57
B	86	70	73	70	

All Dimension are in mm

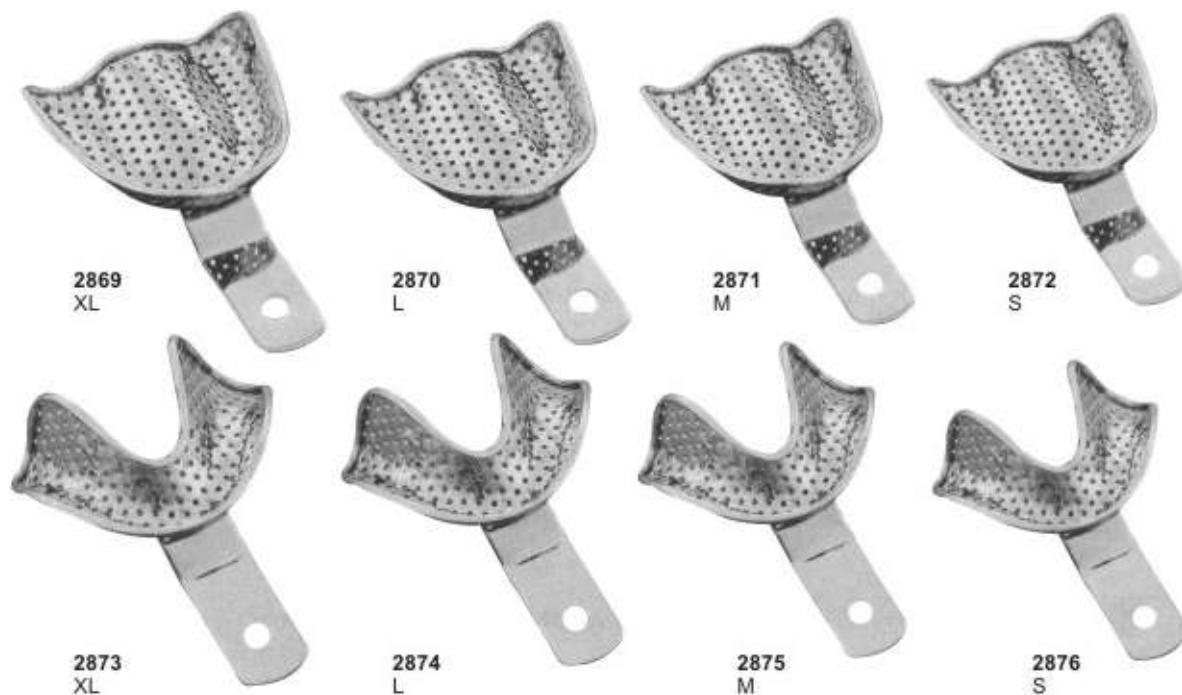

Perforated Full Denture Set of 8





# MOSSIDENT

Dental Surgical Instruments Supplier

Surgery Instruments  
instrumentos de cirugia  
instruments de chirurgie  
ascensori per radici  
أدوات الجراحة



## IMPRESSION TRAYS

Made of 18/8 Stainless Steel, Solid Set of 6



2877  
U1



2878  
U2



2879  
U3



2880  
L1



2881  
L2



2882  
L3

All The Above Impression Trays are Available in These 4 Sizes

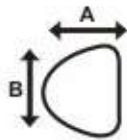

UPPER	U1	U2	U3
A	67	64	57
B	81	71	70

All Dimension are in mm

LOWER	L1	L2	L3
A	60	57	54
B	81	79	76

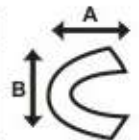

All Dimension are in mm



2883  
U1



2884  
U2



2885  
U3



2886  
L1



2887  
L2



2888  
L3

Perforated Set of 6





**MOSSIDENT**

Dental Surgical Instruments Supplier

Surgery Instruments  
 instrumentos de cirugia  
 instruments de chirurgie  
 ascensori per radici  
 أدوات الجراحة



**IMPRESSION TRAYS**

Made of 18/8 Stainless Steel, English Pattern Set of 8



2889  
Lower



2890  
Upper

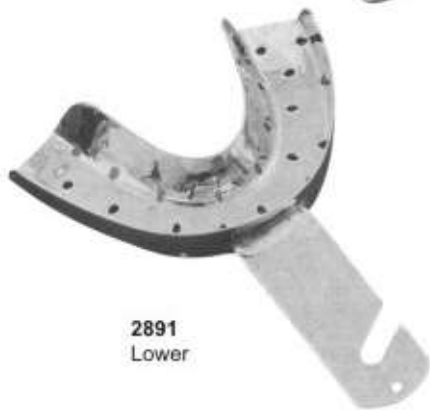

2891  
Lower



2892  
Upper



2893  
Lower



2894  
Upper

All The Above Impression Trays are Available in These 4 Sizes

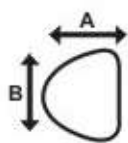

UPPER	Size	A	B	C
	0	67	50	12
	1	72	51	13
	2	78	55	15
	3	80	58	15

All Dimension are in mm

LOWER	Size	A	B	C
	0	70	50	14
	1	77	51	15
	2	79	55	15
	3	80	60	17

All Dimension are in mm

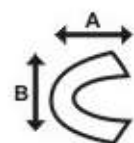



# MOSSIDENT

Dental Surgical Instruments Supplier

Surgery Instruments  
instrumentos de cirugia  
instruments de chirurgie  
ascensori per radici  
أدوات الجراحة



## IMPRESSION TRAYS

Made of 18/8 Stainless Steel, Solid Full Denture Set of 8

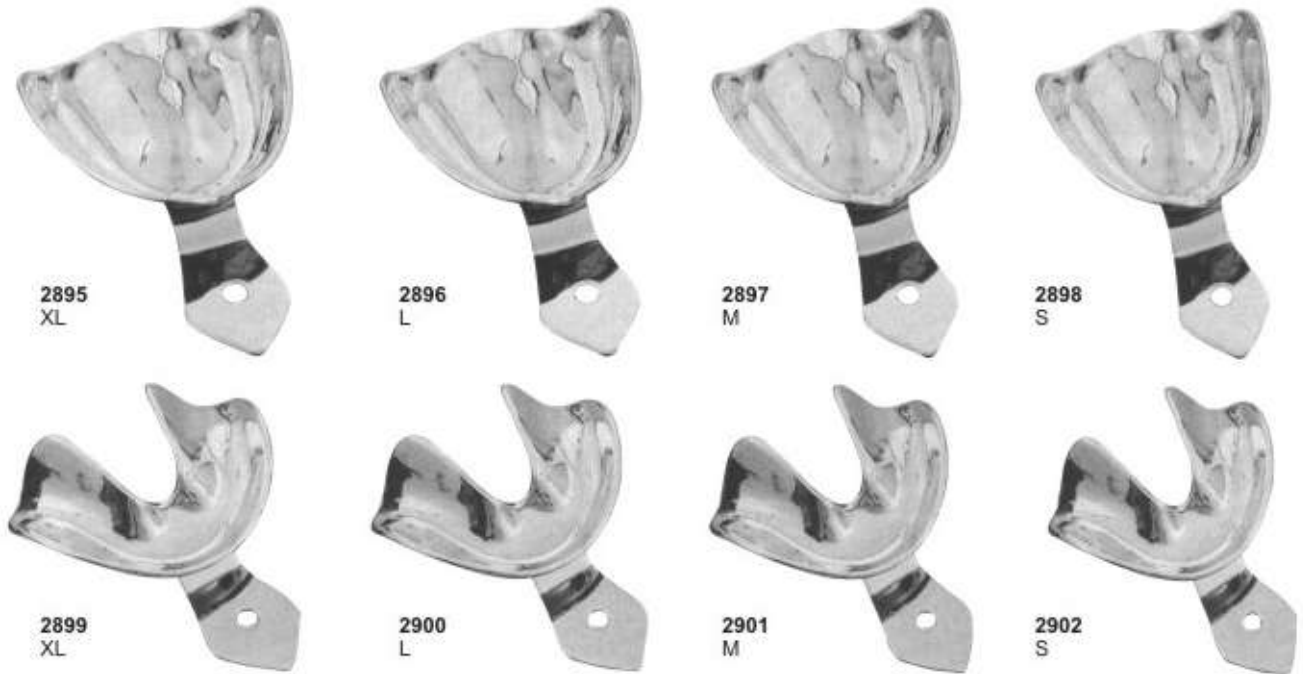

All The Above Impression Trays are Available in These 4 Sizes

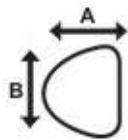

UPPER		XL	L	M	S
	A	70	67	64	60
B	79	76	70	73	

All Dimension are in mm

LOWER		XL	L	M	S
	A	64	64	60	57
B	86	70	73	70	

All Dimension are in mm

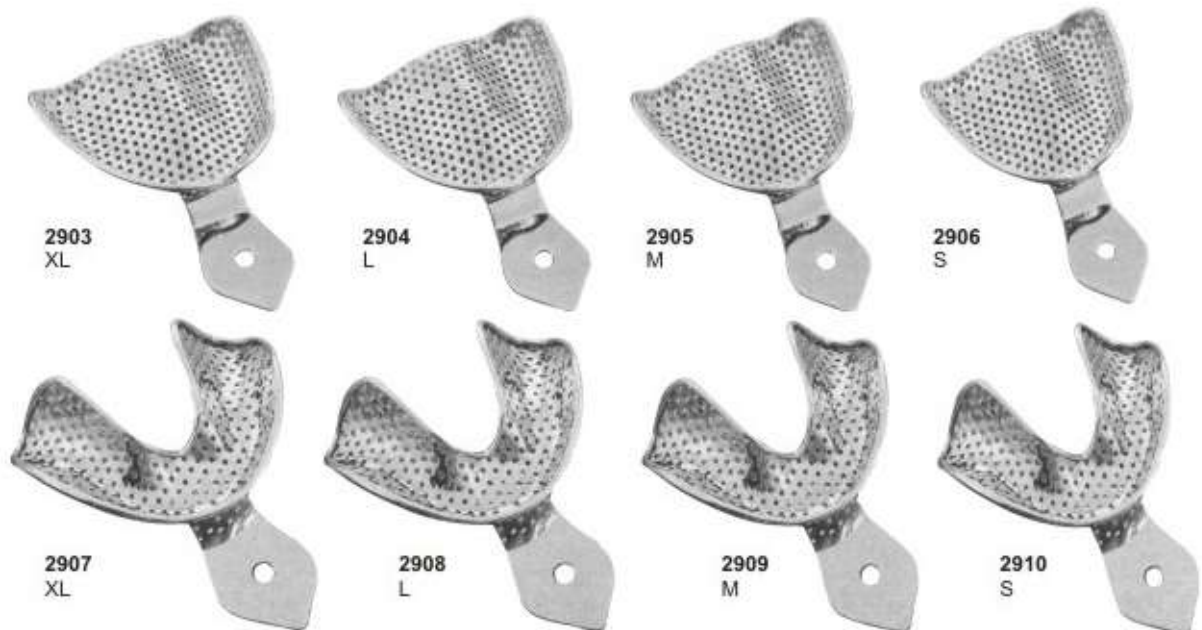

Made of 18/8 Stainless Steel, Perforated Full Denture Set of 8



**MOSSIDENT**  
Dental Surgical Instruments Supplier

Surgery Instruments  
instrumentos de cirugia  
instruments de chirurgie  
ascensori per radici  
أدوات الجراحة



## IMPRESSION TRAYS

Made of 18/8 Stainless Steel, Solid Full Denture Set of 8

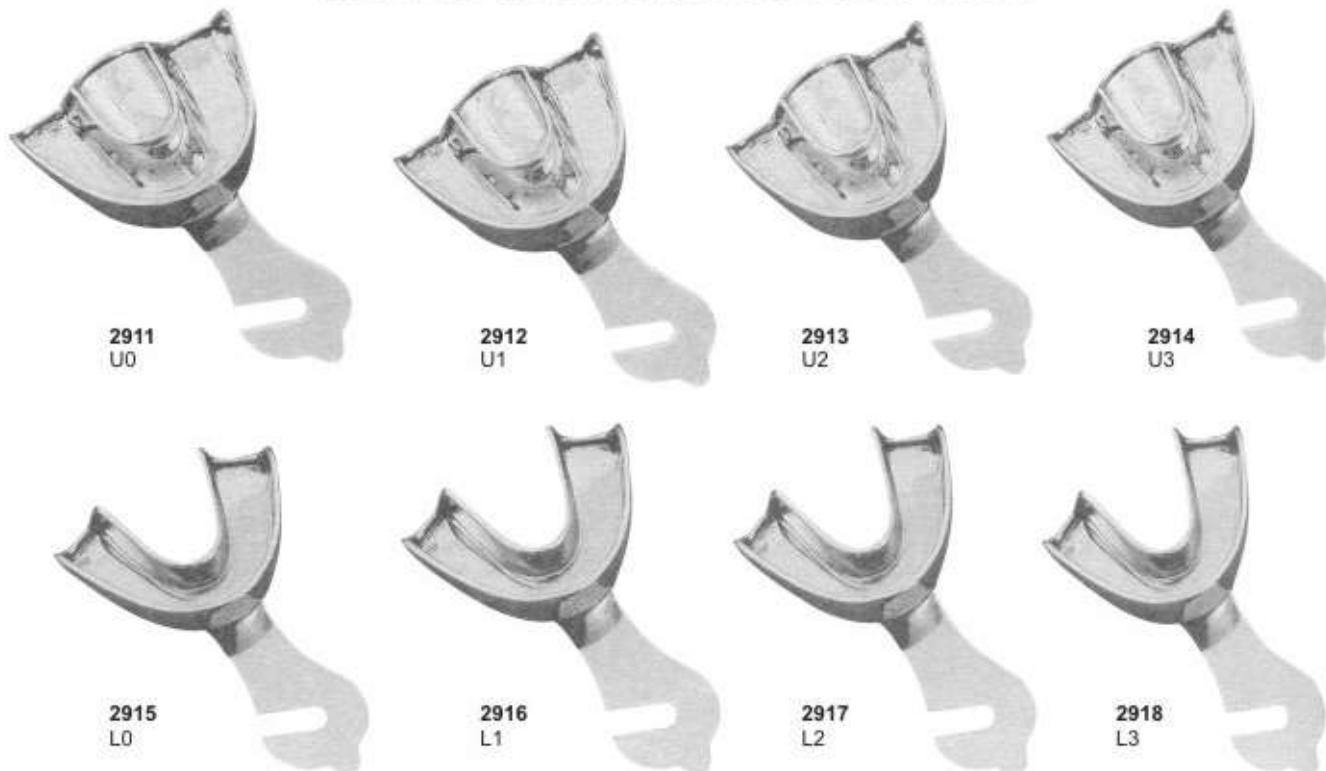

Upper Sizes: 0,1,2,3

Depth of Tray: 15,9 mm, Height of Plate: 12,5 mm

Lower Sizes: 0,1,2,3

Depth of Tray: 12,9 mm

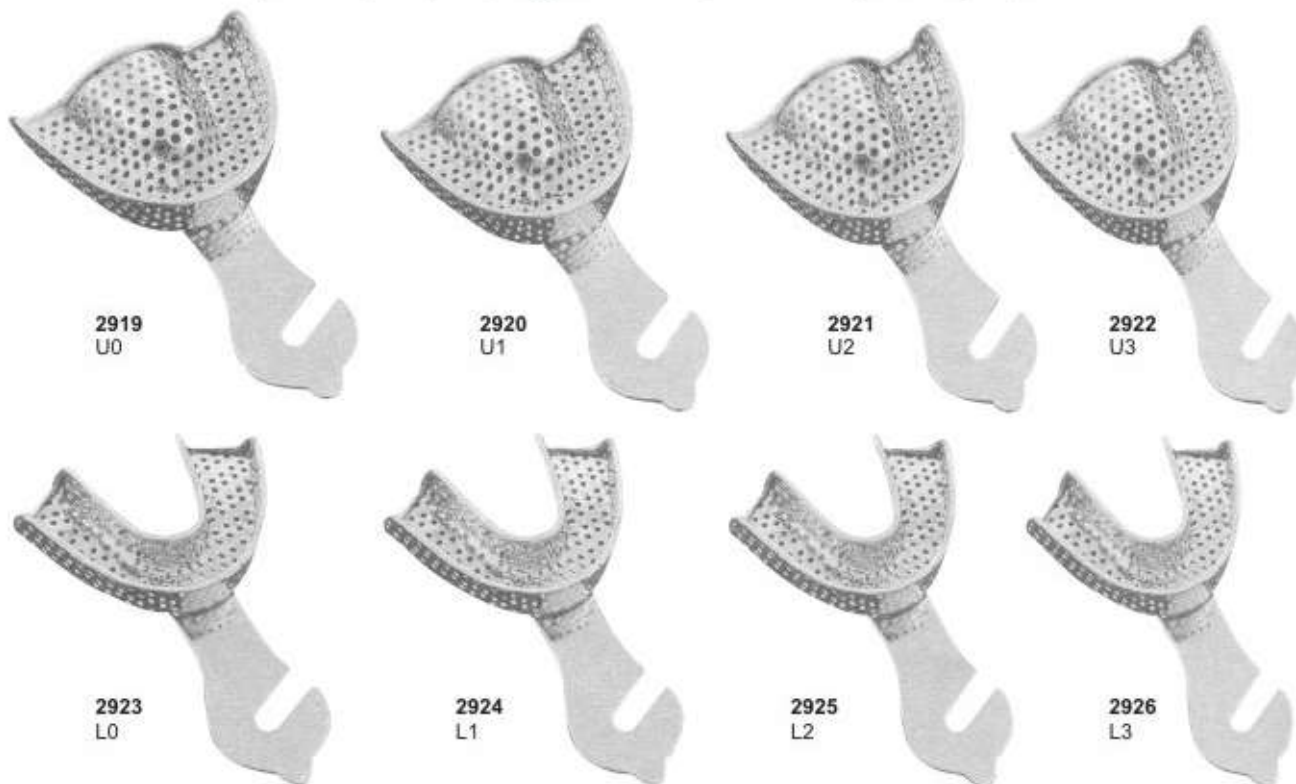

Made of 18/8 Stainless Steel, Perforated Full Denture Set of 8





# MOSSIDENT

Dental Surgical Instruments Supplier

Surgery Instruments  
instrumentos de cirugia  
instruments de chirurgie  
ascensori per radici  
أدوات الجراحة



## IMPRESSION TRAYS

### Impression Trays For Crown & Bridge Work



2927  
U1P



2928  
L1P

**SOLID**



2929  
U1P



2930  
L1P

**PERFORATED**



2932  
Adjustable  
Perforated



2933  
Adjustable  
Solid

**PERFORATED**



2931-A  
For upper right jaw  
For lower left jaw

2931-B  
For upper left jaw  
For lower right jaw

**Available in 4 sizes**

- 1.....44 mm
- 2.....55 mm
- 3.....60 mm
- 4.....65 mm

**SOLID**



2931-C  
For upper right jaw  
For lower left jaw

2931-D  
For upper left jaw  
For lower right jaw

**Available in 4 sizes**

- 1.....44 mm
- 2.....55 mm
- 3.....60 mm
- 4.....65 mm





**MOSSIDENT**

Dental Surgical Instruments Supplier

Surgery Instruments  
instrumentos de cirugia  
instruments de chirurgie  
ascensori per radici  
أدوات الجراحة



## ARTICULATORS



2934



2935



2936



2937



2939



2938



**MOSSIDENT**  
Dental Surgical Instruments Supplier

Surgery Instruments  
instrumentos de cirugia  
instruments de chirurgie  
ascensori per radici  
أدوات الجراحة



## ARTICULATORS



2940



2941



2942



2943



2944



2945



2946



2947



**HOLLOWWARES, INSTRUMENT TRAYS**



**2948**  
Instruments Tray of 20 Pcs



**2951**  
Instruments Riddle



**2949**  
Instruments Tray of 7 Pcs



**2949-A**  
Instruments Tray of 10 Pcs



**2950**  
Instruments Tray of 5 Pcs



**2952**  
Instruments Tray of 5 Pcs

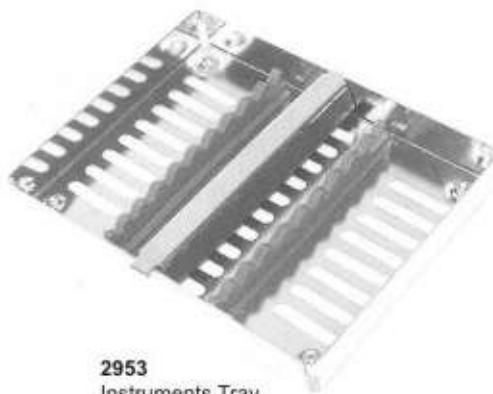

**2953**  
Instruments Tray



**2954**  
Instruments Tray  
Perforated



**2955**  
Instruments Tray  
Perforated Base



**2956**  
Instruments Tray  
Solid Base





# MOSSIDENT

Dental Surgical Instruments Supplier

Surgery Instruments  
instrumentos de cirugia  
instruments de chirurgie  
ascensori per radici  
أدوات الجراحة



## HOLLOWWARES, INSTRUMENT TRAYS



**2957**  
Pulpectomy Tray



**2958**  
Sterilizing Box  
Available Sizes:  
17x17x3 cm  
20x10x6 cm  
30x14x6 cm



**2959**  
Endo Tray Box



**2960**  
Finger Cup



**2961**  
Bur Box

**2962**  
Sterilizing Drum  
150x150mm  
175x175mm  
190x190mm  
200x140mm  
200x200mm  
240x120mm  
225x225mm  
240x240mm  
290x160mm



**2963**  
Sterilizing Drum  
280x240mm  
230x150mm  
300x250mm  
340x160mm  
350x250mm  
390x200mm  
380x300mm  
100x100mm  
150x120mm





**MOSSIDENT**  
Dental Surgical Instruments Supplier

Surgery Instruments  
instrumentos de cirugia  
instruments de chirurgie  
ascensori per radici  
أدوات الجراحة



## STERILIZING BOXES, INSTRUMENT TRAYS



**2964**  
Instruments Box



**2965**  
Instruments Box



**2966**  
Instruments Box



**2967**  
Instruments Sterilizer  
150x75 mm



**2968**  
Endodontic Box



**2969**  
Sterilizing Box  
320x120 mm



**2970**  
Instruments Tray



**2971**  
Instruments Tray



**2972**  
Instruments Tray  
(Perforated)



**2973**  
Instruments Tray  
Shallow(Mayo)



**2974**  
Scaler Tray  
20.0 x 10.0 x 1.5 cm



**2975**  
Scalers Tray



**2976**  
Scalers Tray



**HOLLOWWARES**



**2977**

**2978**

**2979**

**2980**

Forcep and Thermometer Jars



**2981**

Cotton Holding Jar  
60x50 mm



**2982**

Spitten Mug



**2983**

Spirit Burner With Wick  
Stainless Steel18/10  
Capacity:150 ml, 60 ml



**2984**

Spirit Burners With Wick  
Stainless Steel18/10  
Capacity:70ml



**2985**

Dressing Jar



**2986**

Dressing Jar



**2987**

Irrigator(Douch Can)



**2988**

Measuring Jug



**HOLLOWWARES**



**2989**  
Sponge Bowl



**2990**  
Wash Basin  
300mm-350mm-400mm



**2991**  
Sponge Bowl



**2992**  
Gallipot



**2993**  
Medicine Cup



**2994**  
Kick Bucket With Trolley



**2995**  
Kidney Tray Shallow  
150mm-200mm-240mm-300mm



**2996**  
Kidney Tray Without Lid  
150mm-200mm-250mm-300mm



**2997**  
Kidney Tray With Lid  
150mm-200mm-250mm-300mm



**2998**  
Tube Rack, Stainless Steel 18/10



**2999**  
Needle Case Rectangle  
Needle Case Round With Cover  
90x15



**3000**  
Dustbin Without Stand  
6-10-12 Ltr



**3001**  
Tube Rack, Round Model  
Stainless Steel 18/10



**3002**  
Dustbin Without Stand & Cap  
6-10-12 Ltr



**3003**  
Lotions Bowl With Lip  
40-60-80-100-120-150-18





**MOSSIDENT**  
Dental Surgical Instruments Supplier

Surgery Instruments  
instrumentos de cirugia  
instruments de chirurgie  
ascensori per radici  
أدوات الجراحة



## SCISSORS TC , TUNGSTEN CARBIDE INSERT



**3004**  
Standard

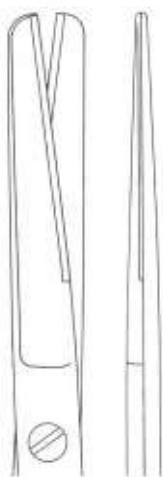

14,5cm  
16,5cm  
18,5cm



**3005**  
Standard

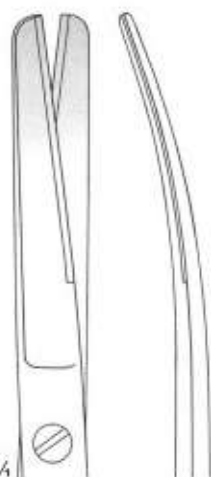

14,5cm  
16,5cm  
18,5cm



**3006**  
Standard

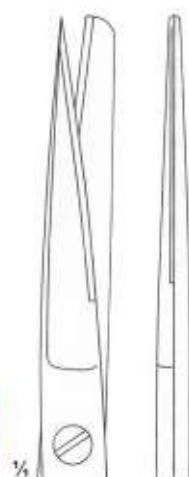

14,5cm  
16,5cm  
18,5cm



**3007**  
Standard



14,5cm  
16,5cm  
18,5cm



**3008**  
Standard



14,5cm  
16,5cm  
18,5cm



**3009**  
Standard

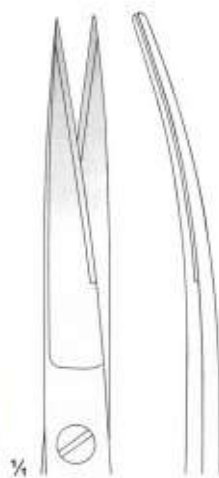

14,5cm  
16,5cm  
18,5cm





# MOSSIDENT

Dental Surgical Instruments Supplier

Surgery Instruments  
instrumentos de cirugia  
instruments de chirurgie  
ascensori per radici  
أدوات الجراحة



## SCISSORS TC , TUNGSTEN CARBIDE INSERT

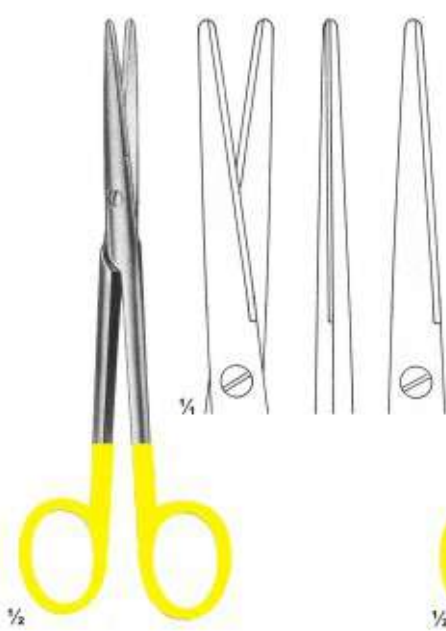

**3010**  
MAYO-LEXER  
Straight  
16 cm

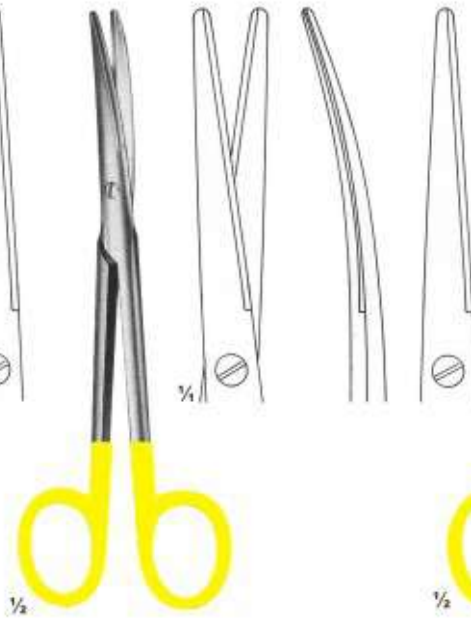

**3011**  
MAYO-LEXER  
Curved  
16 cm

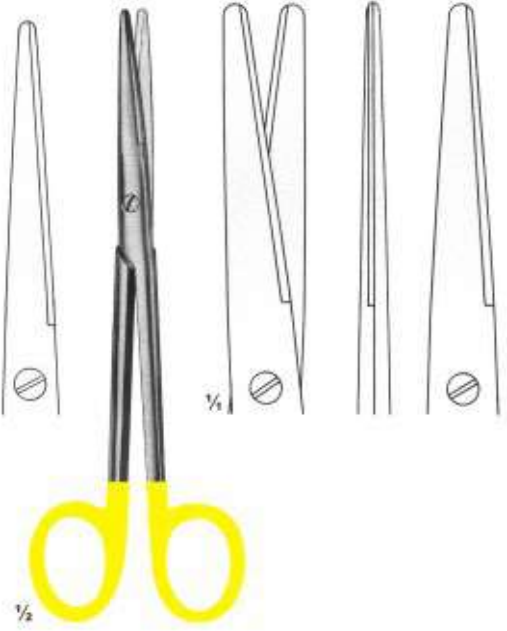

**3012**  
LEXER  
Straight  
16, 21 cm



**3013**  
LEXER  
Curved  
16, 21 cm

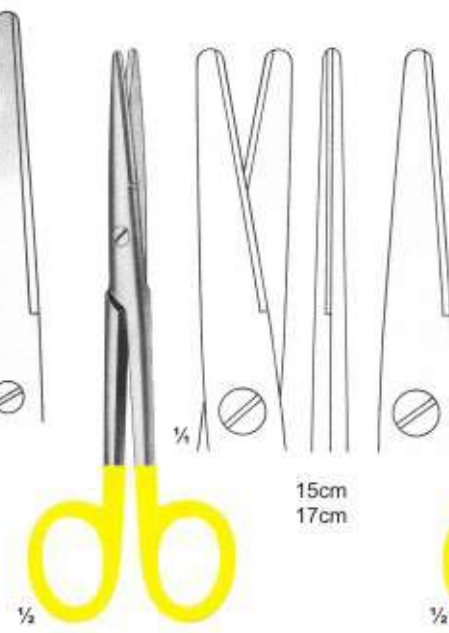

**3014**  
MAYO-STILLE  
Straight  
15,17 cm

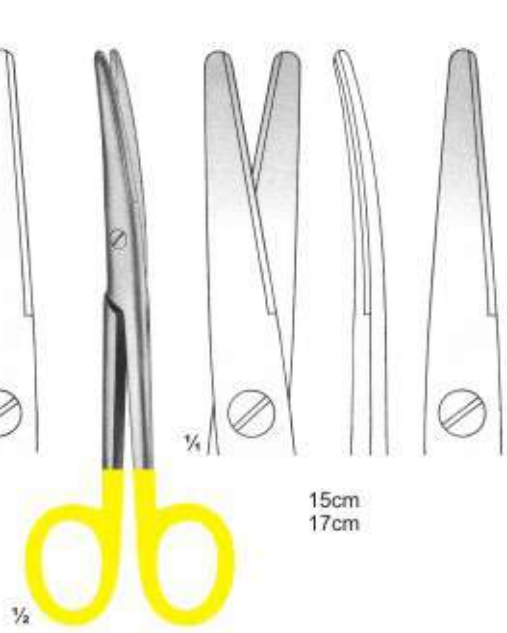

**3015**  
MAYO-STILLE  
Curved  
15,17 cm



# MOSSIDENT

Dental Surgical Instruments Supplier

Surgery Instruments  
instrumentos de cirugia  
instruments de chirurgie  
ascensori per radici  
أدوات الجراحة



## SCISSORS TC , TUNGSTEN CARBIDE INSERT



18cm  
20cm  
28cm  
30cm

11,5cm  
14,5cm  
23,5cm  
25,5cm

**3016**  
METZENBAUM  
Straight



11,5cm  
23cm

14,5cm  
25cm

**3017**  
METZENBAUM  
Curved

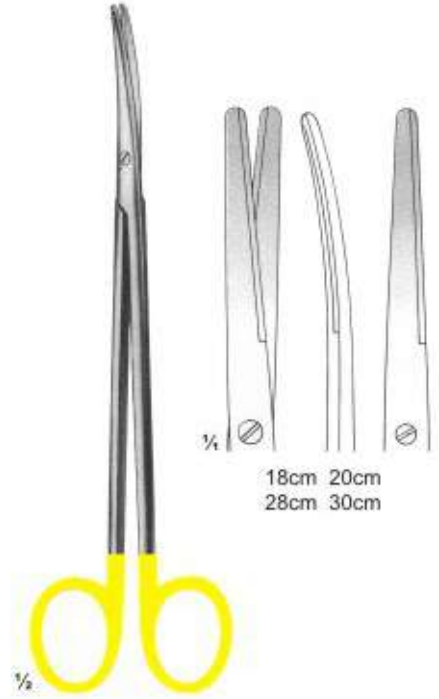

18cm  
20cm  
28cm  
30cm

**3018**  
METZENBAUM  
Curved



14cm  
23cm

18cm  
25cm

20cm  
28cm

**3019**  
METZENBAUM FINO  
Straight



14cm  
23cm

18cm  
25cm

20cm  
28cm

**3020**  
METZENBAUM FINO  
Curved



14cm  
20cm

18cm  
23cm

**3021**  
METZENBAUM FINO  
Sharp

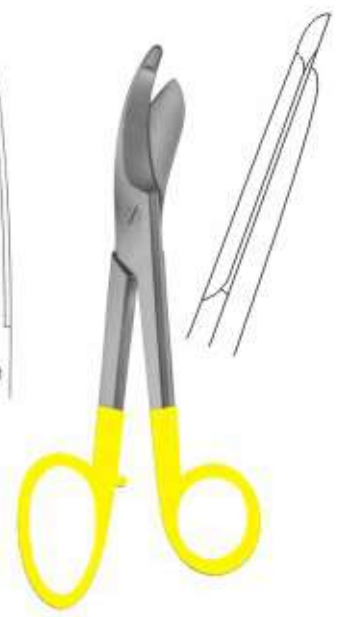

**3022**  
BRUNS  
235 mm



# MOSSIDENT

Dental Surgical Instruments Supplier

Surgery Instruments  
instrumentos de cirugia  
instruments de chirurgie  
ascensori per radici  
أدوات الجراحة



## SCISSORS TC , TUNGSTEN CARBIDE INSERT

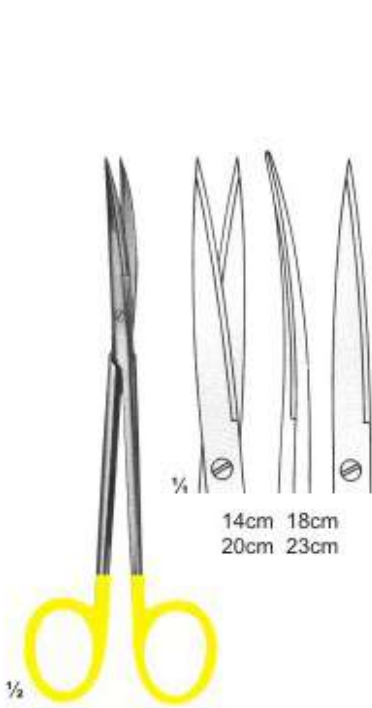

**3023**  
METZENBAUM FINO

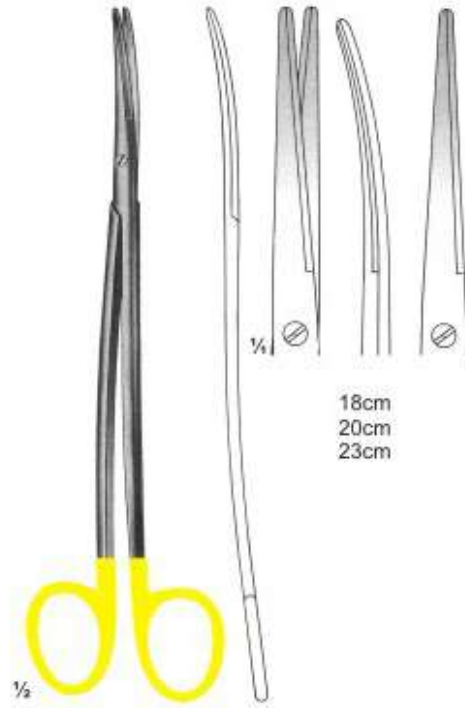

**3024**  
METZENBAUM FINO

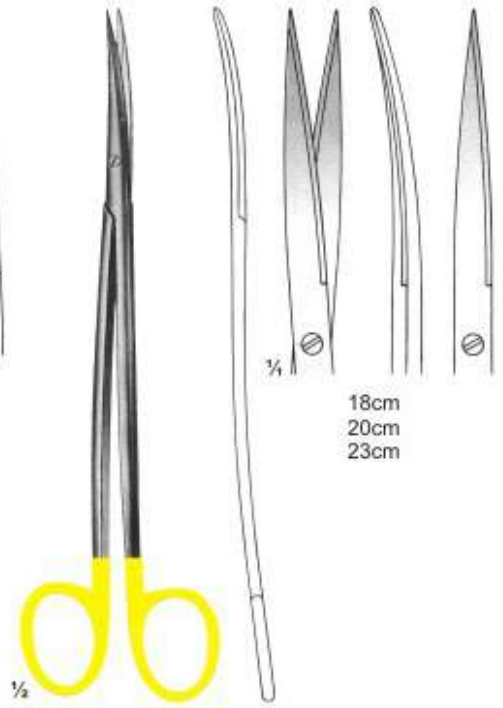

**3025**  
METZENBAUM FINO

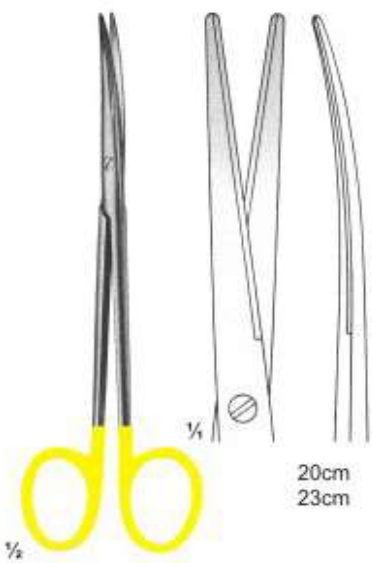

**3026**  
METZENBAUM FINO

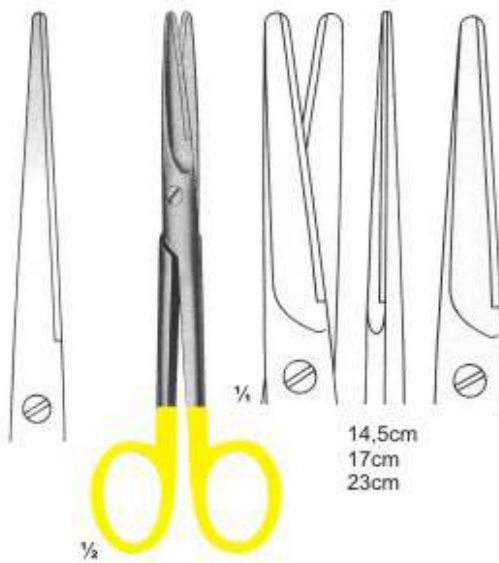

**3027**  
MAYO  
Straight

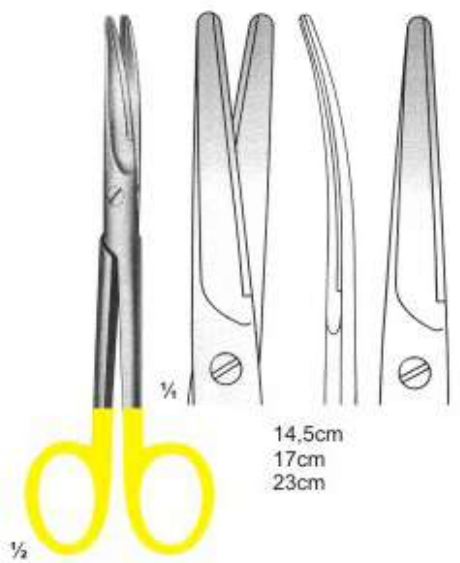

**3028**  
MAYO  
Curved



# MOSSIDENT

Dental Surgical Instruments Supplier

Surgery Instruments  
instrumentos de cirugia  
instruments de chirurgie  
ascensori per radici  
أدوات الجراحة



## SCISSORS TC , TUNGSTEN CARBIDE INSERT

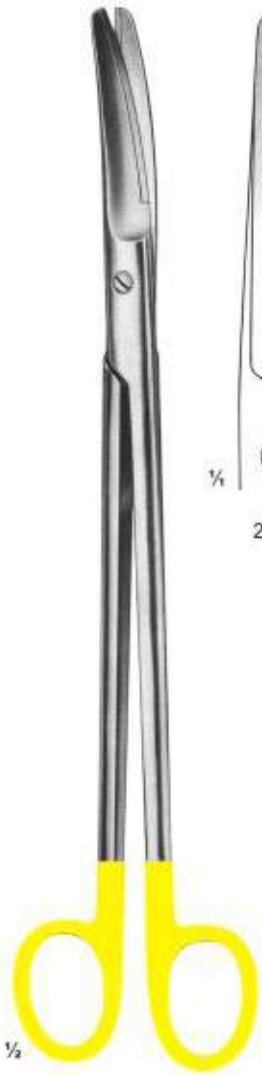

**3029  
SIMS**



23cm

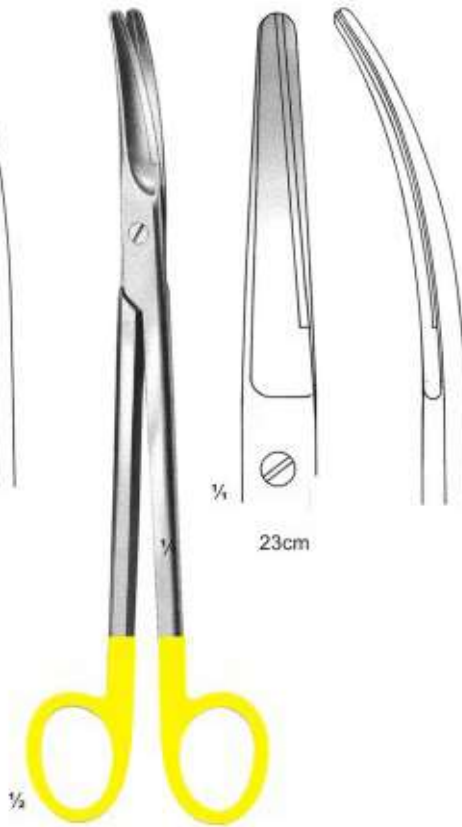

**3030  
PARAMETRIUM**



23cm

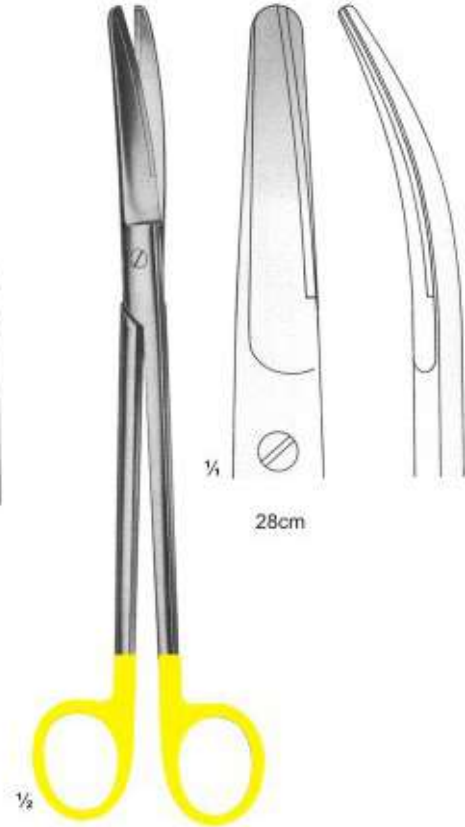

**3031  
MAYO-HARRINGTON**

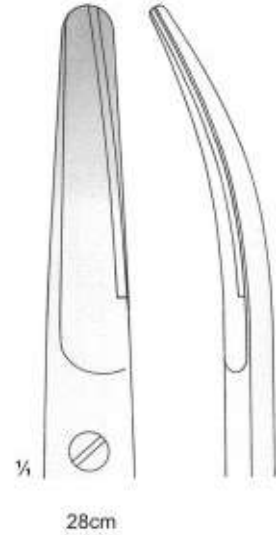

28cm



**3032  
KELLY  
Straight 16 cm**



**3033  
KELLY  
Curved 16 cm**



**3034  
DEAN  
17 cm**



**3035  
LAGRANGE  
Double-Curved  
11.5 cm**





# MOSSIDENT

Dental Surgical Instruments Supplier

Surgery Instruments  
instrumentos de cirugia  
instruments de chirurgie  
ascensori per radici  
أدوات الجراحة



## SCISSORS TC , TUNGSTEN CARBIDE INSERT



**3036**  
DE-BAKEY



**3037**  
DE-BAKEY

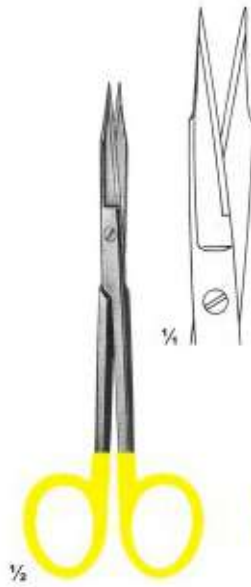

**3038**  
GOLDMAN FOX  
13 cm



**3039**  
GOLDMAN FOX  
Double-Curved  
13 cm

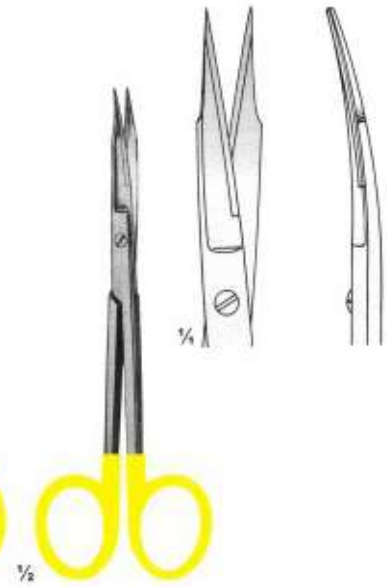

**3040**  
GOLDMAN FOX  
13 cm

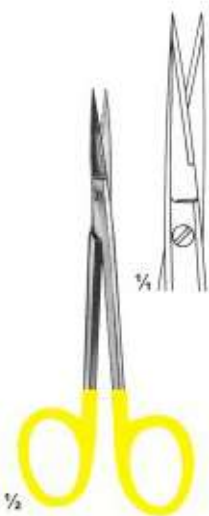

**3041**  
Fine Scissors  
Straight  
11, 5 cm

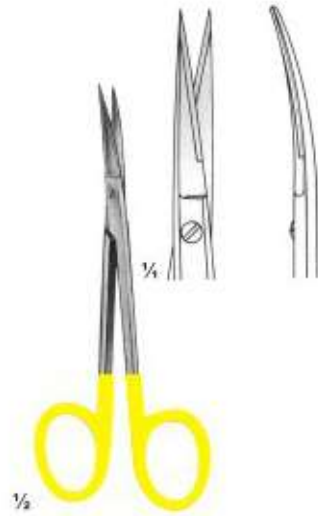

**3042**  
Fine Scissors  
Curved  
11, 5 cm



**3043**  
Fine Scissors  
Angled  
11, 5 cm

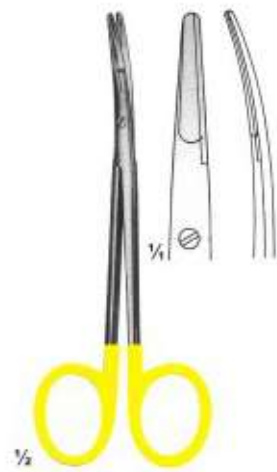

**3044**  
RAGNELL  
Curved  
12 cm



# MOSSIDENT

Dental Surgical Instruments Supplier

Surgery Instruments  
instrumentos de cirugia  
instruments de chirurgie  
ascensori per radici  
أدوات الجراحة



## SCISSORS TC , TUNGSTEN CARBIDE INSERT



**3045**  
UNIVERSAL  
12cm

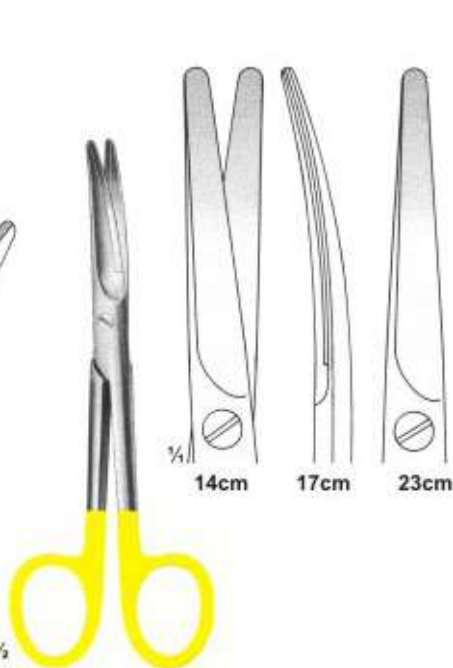

**3046**  
Ligature Scissors  
1 Black & 1 Goldplated ring



**3047**  
MERIAM  
16 cm



**3048**  
ADSON

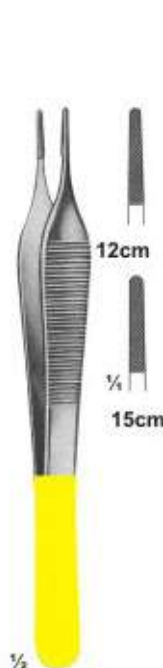

**3049**  
ADSON



**3050**  
CUSHING  
17,5 cm

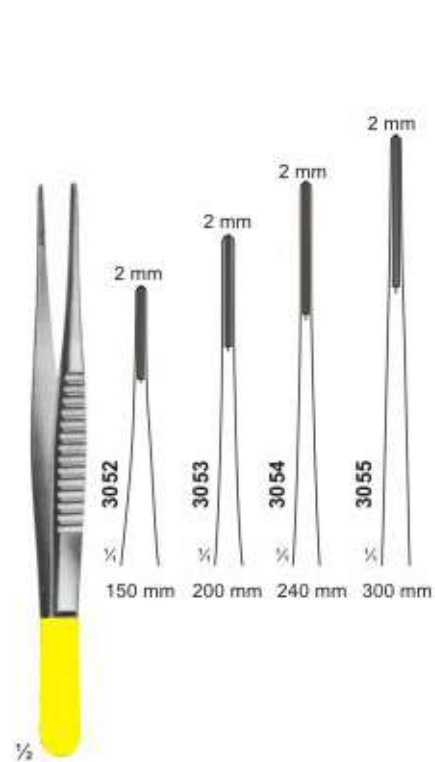

**3051**  
DE BAKEY  
17,5 cm



**3056**  
CASTROVIEJO  
Curved  
15 cm



**3057**  
CUSHING  
18 cm



**3058**  
CUSHING-  
TAYLOR  
18 cm



**3059**  
Dressing  
Forceps  
15 cm



**3060**  
SEMKEN  
15 cm



**3061**



# MOSSIDENT

Dental Surgical Instruments Supplier

Surgery Instruments  
instrumentos de cirugia  
instruments de chirurgie  
ascensori per radici  
أدوات الجراحة



## SCISSORS TC , TUNGSTEN CARBIDE INSERT

**3062 WANGENSTEEN**  
15cm  
23cm  
25cm

**3063 POTTS-SMITH**  
15cm  
18cm  
20cm  
23cm  
25cm

**3064 OEHLER**  
14cm  
20cm  
16cm  
25cm  
18cm  
30cm

**3065 POTTS-SMITH**  
22 cm

**3066 ARRUGA**  
16 cm

**3067 HEPP-SCHIEDLE**  
18 cm

**3068 KALT**  
with catch  
135 mm

**3069 CASTROVIEJO**  
Straight  
14 cm

**3070 CASTROVIEJO**  
Curved  
14 cm

**3071 CASTROVIEJO**  
Straight  
14 cm

**3072 CASTROVIEJO**  
Curved  
14 cm

**3073 A Cvd**

**3073 CASTROVIEJO**  
Straight

**3074 B Cvd**

**3074 CASTROVIEJO**  
Stra





# MOSSIDENT

Dental Surgical Instruments Supplier

Surgery Instruments  
instrumentos de cirugia  
instruments de chirurgie  
ascensori per radici  
أدوات الجراحة



## SCISSORS TC , TUNGSTEN CARBIDE INSERT



**3075**  
ARRUGA  
Curved  
16 cm

**3076**  
CASTROVIEJO  
13 cm

**3077**  
HEGAR  
20,24 cm

**3078**  
SMOOTH TIP  
15 cm

**3079**  
HALSEY  
13,15 cm

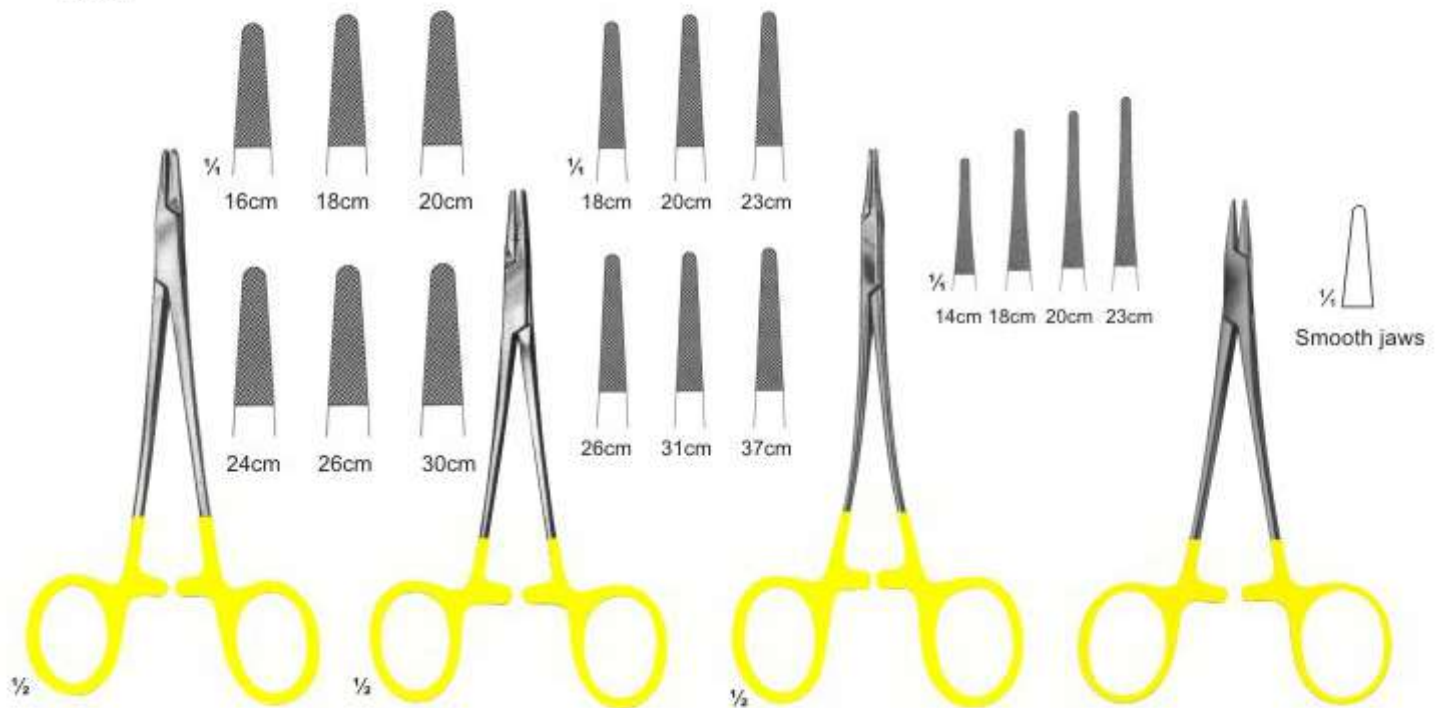

**3080**  
MAYO-HEGAR

**3081**  
DE BAKEY

**3082**  
HEGAR-VASCULAR

**3083**  
WEBSTER  
125 mm





**MOSSIDENT**  
Dental Surgical Instruments Supplier

Surgery Instruments  
instrumentos de cirugia  
instruments de chirurgie  
ascensori per radici  
أدوات الجراحة



## SCISSORS TC , TUNGSTEN CARBIDE INSERT

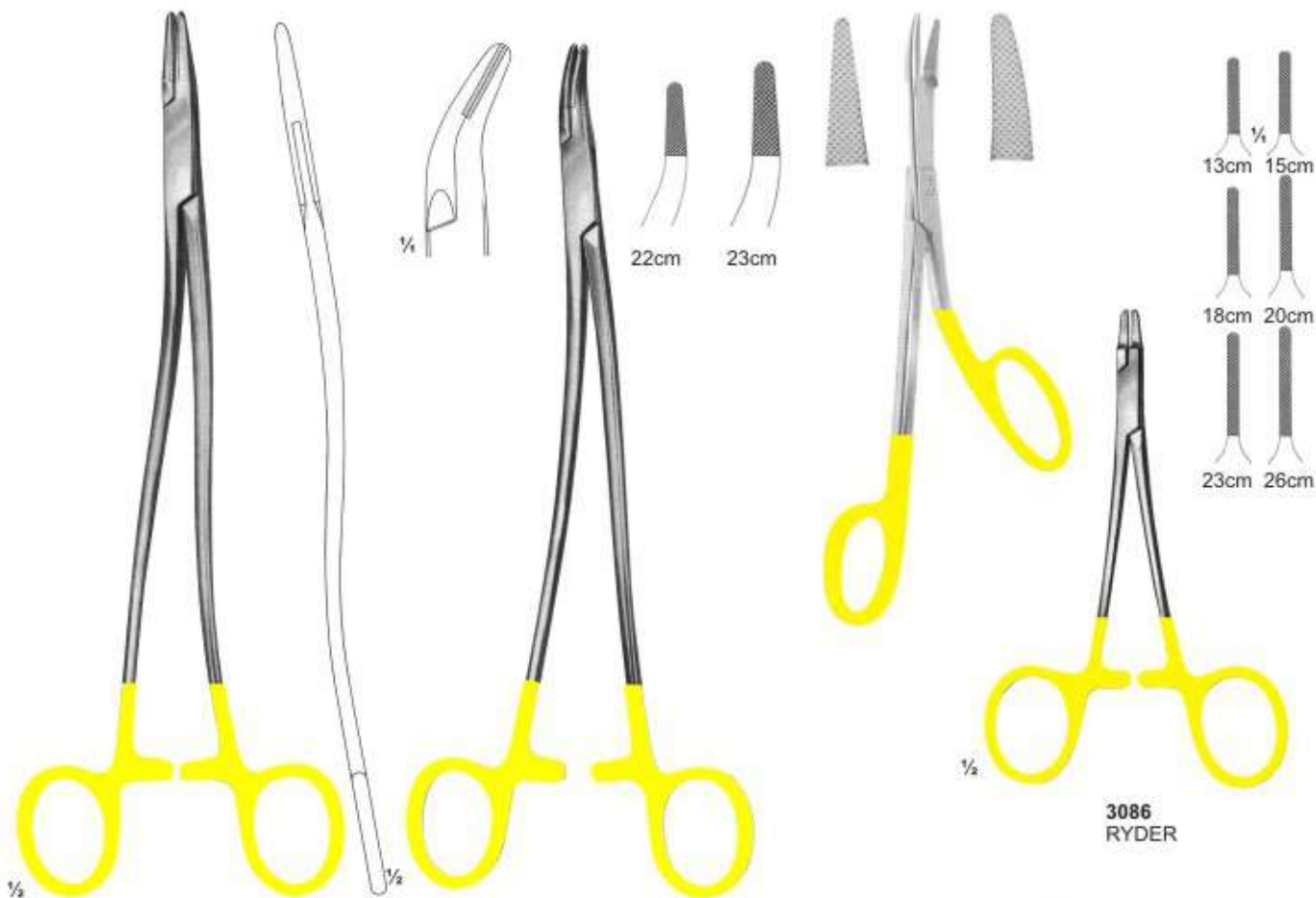

**3084**  
BOZEMANN-WERTHEIM  
20, 24, 26 cm

**3085**  
STRATTE

**3086**  
RYDER



**3087**  
RYDER-VASCULAR

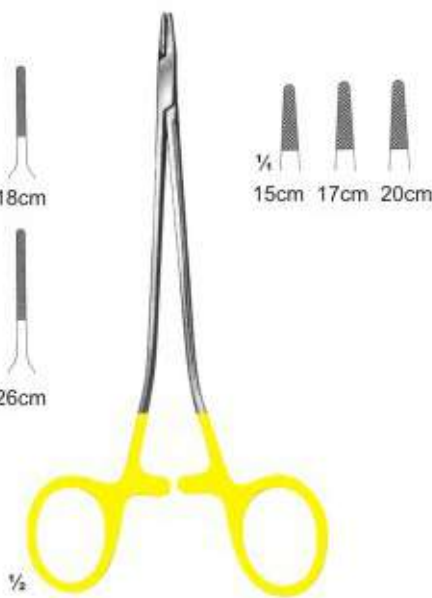

**3088**  
MARTIN

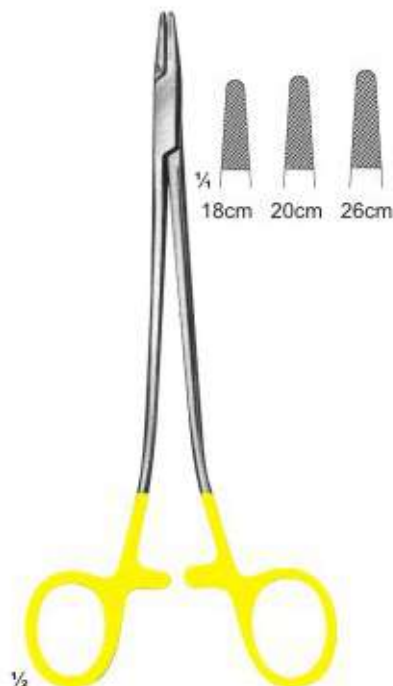

**3089**  
SAROT



# MOSSIDENT

Dental Surgical Instruments Supplier

Surgery Instruments  
instrumentos de cirugia  
instruments de chirurgie  
ascensori per radici  
أدوات الجراحة



## SCISSORS TC , TUNGSTEN CARBIDE INSERT

27 cm

14cm 17cm 20cm

3090 FINOCHIETTO  
27 cm

3091 HEANEY  
27,24 cm

3092 BAUMGARTNER  
145 mm

3093 CRILE-WOOD  
15 cm

3094 MATHIEU

3095 MATHIEU  
14,17,20 cm

3096 MATHIEU-KOSHER  
14,17,20,24 cm

3097 MATHIEU-KOSHER  
17,20,24 cm

3098 MATHIEU-VASCULAR  
17,20,24 cm

3099 MATHIEU-VASCULAR  
Hosel  
17,20 cm



**MOSSIDENT**  
Dental Surgical Instruments Supplier

Surgery Instruments  
instrumentos de cirugia  
instruments de chirurgie  
ascensori per radici  
أدوات الجراحة



## SCISSORS TC , TUNGSTEN CARBIDE INSERT

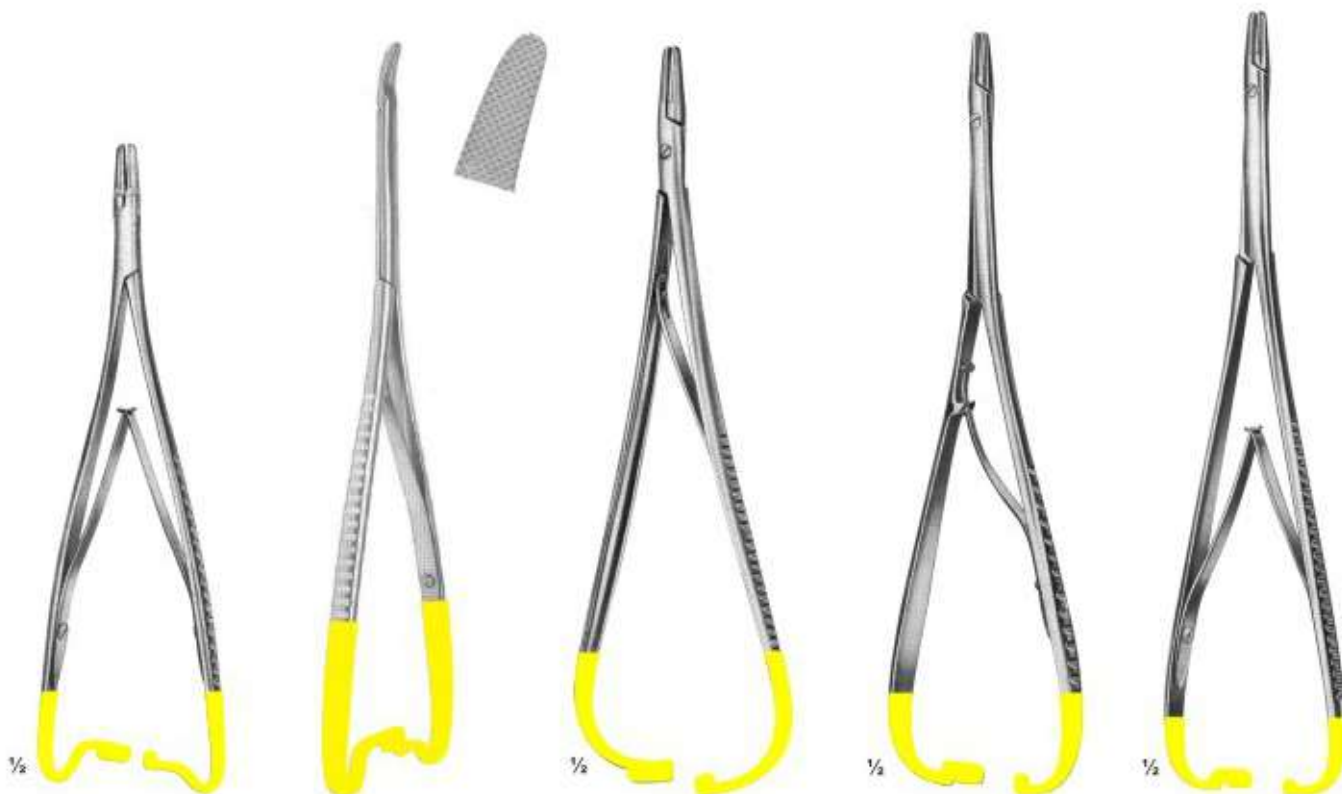

**3100**  
MATHIEU-RYDER  
17,20,24 cm

**3101**  
Hosel  
Curved  
20 cm

**3102**  
LICHTENBERG  
20 cm

**3103**  
LANGHALS  
20,25 cm

**3104**  
LICHTENBERG  
20,25 cm



**3105**  
LUEHTY-BECK  
20,25 cm



**3106**  
LUEHTY-BECK  
20,25 cm



**3107**  
LANGENBECK  
18,20,23 cm



**3108**  
LANGENBECK  
18,20,23 cm



# MOSSIDENT

Dental Surgical Instruments Supplier

Surgery Instruments  
instrumentos de cirugia  
instruments de chirurgie  
ascensori per radici  
أدوات الجراحة



## SCISSORS TC , TUNGSTEN CARBIDE INSERT



**3109**  
**TOENNIS**  
Elastic pattern for  
dura-or intestinal suture  
180 mm



**3110**  
**Cutting Plier**  
12 cm

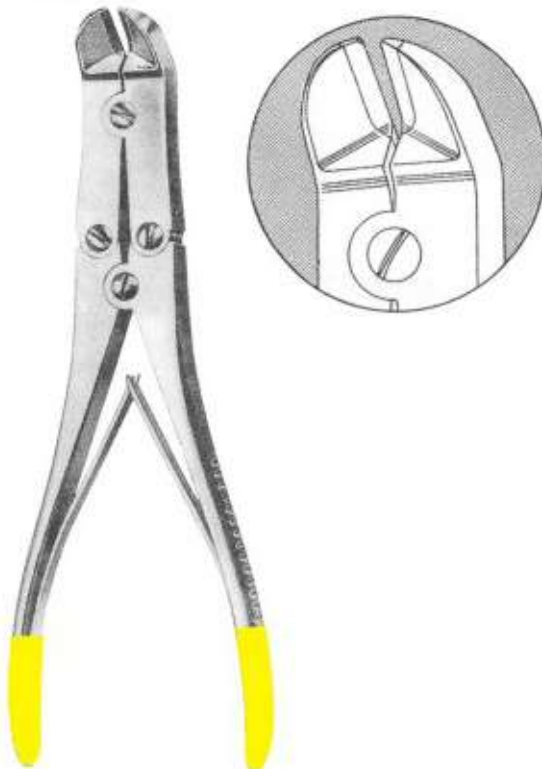

**3111**  
**MULLAR CLAUS**  
22 cm



**3112**  
**Plier**  
17.5 cm





**MOSSIDENT**

Dental Surgical Instruments Supplier

Extracting Forceps  
fórceps de extracción  
forceps d'extraction  
pinze da estrazione  
ملقط الاستخراج



## DIFFERENT KITS



**3113**

Extracting Forceps Kits



**3114**

Extracting Forceps Kits

Fig: 1  
Fig: 7  
Fig: 13  
Fig: 17  
Fig: 22  
Fig: 33  
Fig: 45  
Fig: 51  
Fig: 67  
Fig: 79

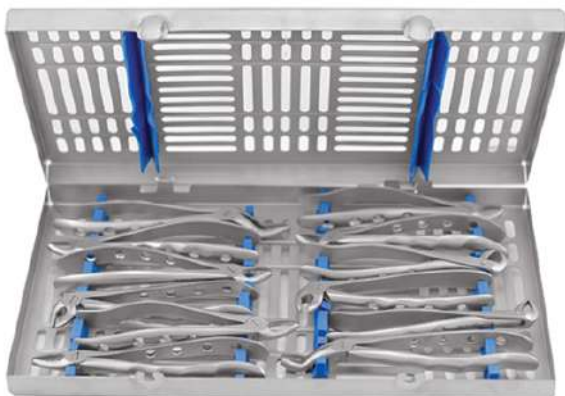

**3115**

Extracting Forceps Kits



**3116**

Extracting Forceps Kits



**MOSSIDENT**

Dental Surgical Instruments Supplier

Extracting Forceps  
fórceps de extracción  
forceps d'extraction  
pinze da estrazione  
ملقط الاستخراج



**FOR CHILDRENS/ KITS**



**3117**

Baby Extracting Forceps Kits



**3118**

Baby Extracting Forceps Kits



**3119**

Baby Extracting Forceps Kits



**3120**

Baby Extracting Forceps Kits





# MOSSIDENT

Dental Surgical Instruments Supplier

Root Elevators  
elevadores de raíces  
élevateurs de racine  
ascensori per radici  
مصاعد جذرية



## PERIOSTEEL ELEVATORS/ KITS



**3120**  
Root Elevators



**3121**  
Root Elevators



**3122**  
Root Elevators



**3123**  
Root Elevators



**3124**  
Root Elevators



**MOSSIDENT**

Dental Surgical Instruments Supplier

Root Elevators  
elevadores de raíces  
élevateurs de racine  
ascensori per radici  
مصاعد جذرية



## LUXATOR ELEVATORS/ KITS

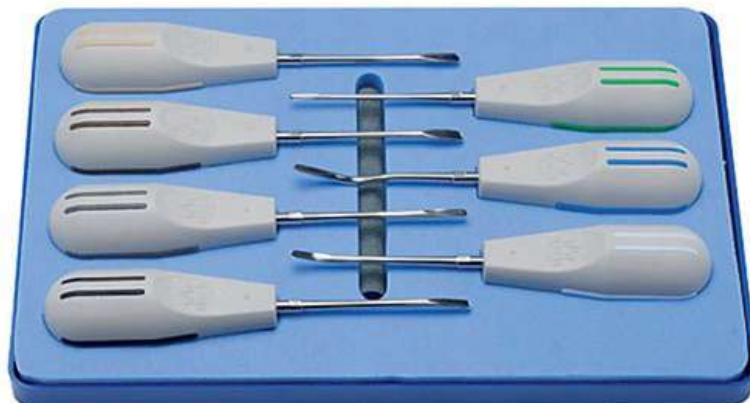
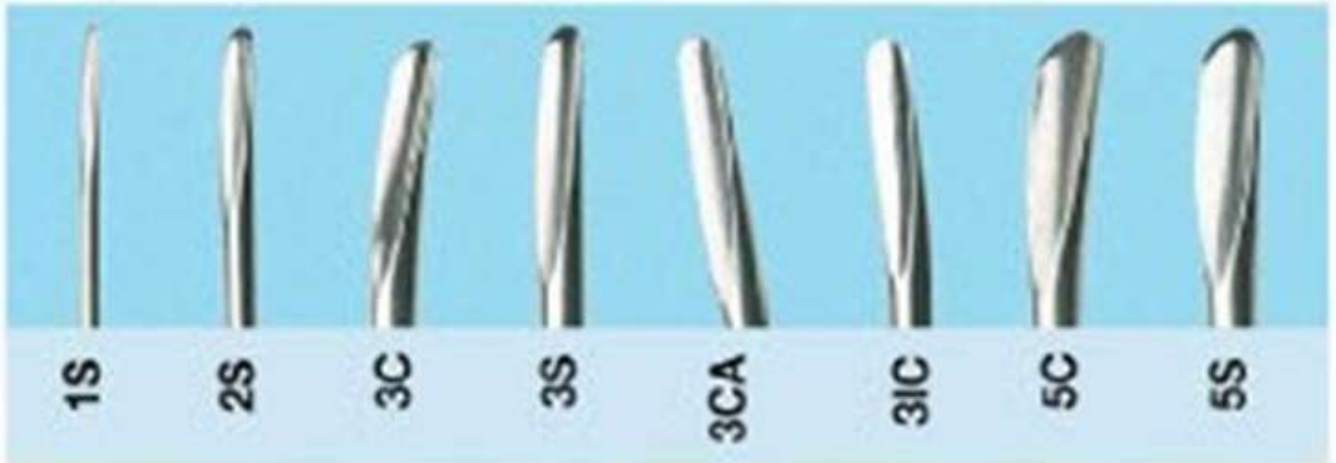

**3125**  
Luxator Elevators





# MOSSIDENT

Dental Surgical Instruments Supplier

Surgery Instruments  
instrumentos de cirugia  
instruments de chirurgie  
ascensori per radici  
أدوات الجراحة



## PDL ELEVATORS/ KITS



**3125**  
PDL Elevators





**MOSSIDENT**

Dental Surgical Instruments Supplier

Surgery Instruments  
instrumentos de cirugia  
instruments de chirurgie  
ascensori per radici  
أدوات الجراحة



**GRACEY SET/ KITS**



**3126**  
Gracey Set

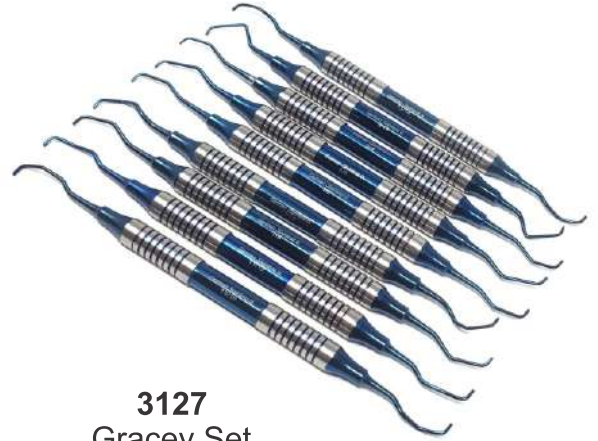

**3127**  
Gracey Set



**3128**  
Gracey Set



**3129**  
Gracey Set



**3130**  
Gracey Set





# MOSSIDENT

Dental Surgical Instruments Supplier

Surgery Instruments  
instrumentos de cirugia  
instruments de chirurgie  
ascensori per radici  
أدوات الجراحة



## OSTEOTOM SET/ KIT

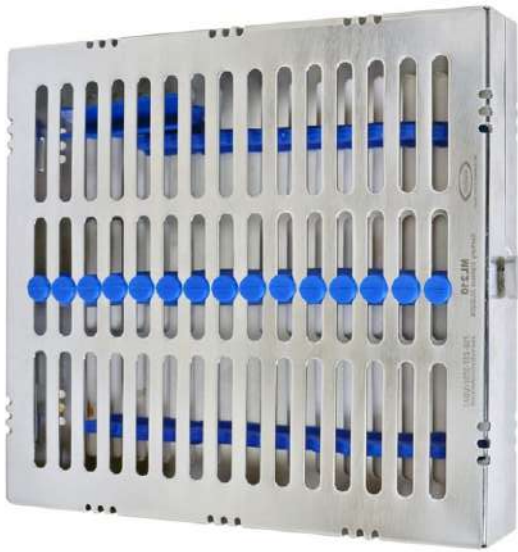

**3131**  
Gracey Set



**3132**  
Gracey Set

*Choice of every dentist*



**MOSSIDENT**

Dental Surgical Instruments Supplier

## Contacts

+92-315-6144854 

[www.mossident.com](http://www.mossident.com)

[info@mossident.com](mailto:info@mossident.com)

[mossident@gmail.com](mailto:mossident@gmail.com)

